

SOUND

---

# BLUES 4.0

Modern Collection

---

IT. BLUES, rilancio di un progetto e di un sistema versatile studiato per essere in sintonia con lo stile e le caratteristiche del contesto nel quale è inserito. Metropolitano o naturale, storico o contemporaneo, è uno spazio ricco di idee e di personalità nel quale riconoscere se stessi. Blues permette di scoprire nuovi modi di abitare sviluppando la propria cultura della casa e dell'arredo. Firmata BMT in collaborazione con lo Studio Lorenzo Granocchia.

EN. BLUES, the relaunch of a project and of a versatile system designed to be in harmony with the style and characteristics of the context in which it is integrated. Metropolitan or natural, historical or contemporary, it is a space full of ideas and personality in which to recognize the reflection of one's true self. Blues allows to discover new ways of inhabiting spaces through the development of your own idea of home and furniture. Signed by BMT in collaboration with Studio Lorenzo Granocchia.

FR. BLUES, relance d'un projet et d'un système polyvalent étudié pour être en harmonie avec le style et les caractéristiques du contexte dans lequel il est intégré. Métropolitain ou naturel, historique ou contemporain, c'est un espace plein d'idées et de personnalités dans lequel se reconnaître soi-même. Blues permet de découvrir de nouvelles façons d'habiter en développant sa propre culture de la maison et de l'ameublement. Signée BMT en collaboration avec le Studio Lorenzo Granocchia.

# BLUES

4.01

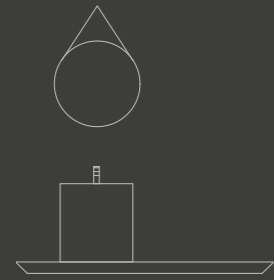

L. 180 cm - P. 50.4 cm - H. 220 cm

Specchio / Mirror / Miroir  
Laccio  
Laccio  
Laccio

Top in legno / Wooden Top / Plan en bois  
Legno Massello Antico - Edon Miele  
Old Wood - Edon Honey  
Bois Massif Antique - Edon Miel

Lavabo / Washbasin / Lavabo  
Tecnoril - Bianco - Funky  
Tecnoril - White - Funky  
Tecnoril - Blanc - Funky





# BLUES

4.01

IT. Volumi rigorosi si accostano tra loro nello spazio creando armonia geometrica. Nella purezza di Funky c'è tutta la funzionalità di un lavabo contenitore in Tecnoril bianco appoggiato sulla tavola di forte spessore con taglio a 45° di legno massello antico Edon Miele.

EN. Rigorous volumes are juxtaposed in space, creating geometric harmony. The purity of Funky reflects the functionality of a washbasin unit in white Tecnoril resting on a very thick table cut at a 45° made using Edon Miele antique solid wood.

FR. Des volumes rigoureux se juxtaposent dans l'espace et créent une harmonie géométrique. On retrouve dans la pureté de Funky toute la fonctionnalité d'une vasque monobloc avec rangements en Tecnoril blanc posée sur le plan de grande épaisseur chanfreiné à 45° en bois massif antique Edon Miele.





# BLUES

4.02

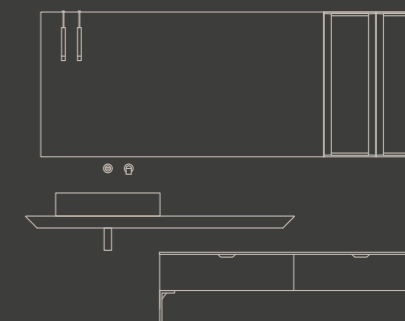

L. 270 cm - P. 50,4 cm - H. 210 cm

Basi / Vanities / Meubles  
 Pensili/Wall-unit/Éléments hauts  
 Cassa / Structure / Caisson  
 Laccato Porfido Opaco  
 Porphyry Matt Lacquered  
 Laqué Porphyre Mat  
 Frontali / Doors / Façades  
 Gres - Pietra Piasentina Grigio Opaco + Alluminio Nero Opaco  
 con vetro Fumè  
 Gres - Matt Grey Piasentina Stone + Black Matt Aluminium with  
 smoky glass  
 Gres - Pierre Piasentina Gris Mat + Aluminium Noir Mat avec ver-  
 re Fumé

Maniglie / Handles / Poignées  
 Craft - Laccato Porfido Opaco  
 Craft - Porphyry Matt Lacquered  
 Craft - Laqué Porphyre Mat

Specchio / Mirror / Miroir  
 Rettangolare  
 Rettangolare  
 Rettangolare

Lampada / Lamp / Lampe  
 Candela Q  
 Candela Q  
 Candela Q

Top / Top / Plan de Toilette  
 Legno Massello Antico - Edon Carbon  
 Old Wood - Edon Carbon  
 Bois Massif Antique - Edon Carbon

Lavabo / Washbasin / Lavabo  
 Gres - Pietra Piasentina Grigio Opaco - Lam 70  
 Gres - Matt Grey Piasentina Stone - Lam 70  
 Gres - Pierre Piasentina Gris Mat - Lam 70

Elementi metallici / Metal elements / Éléments métalliques  
 Metallo - Nero Opaco  
 Metal - Black Matt  
 Métal - Noir Mat



IT. Combinazioni di materiali e di colori per una composizione minimale ed elegante. La tavola in legno massello Edon Carbon con il lavabo in Gres Pietra Piasentina Grigio Opaco è perfettamente in sintonia con i frontali del mobile in appoggio su piedini in metallo. La composizione è completata dal pensile con ante in alluminio di colore nero opaco con vetro fumé.

EN. Combinations of materials and colours for a minimalist and elegant composition. The Edon Carbon solid wood table with the Matt Grey Pietra Piasentina Gres washbasin is in perfect harmony with the furniture fronts resting on metal feet. The composition is complemented by the wall unit featuring matt black aluminium doors with smoked glass.

FR. Combinaisons de matériaux et de couleurs pour une composition minimaliste et élégante. Le plan en bois massif Edon Carbon avec la vasque en Grès Pietra Piasentina Gris Mat est parfaitement en harmonie avec les façades du meuble posé sur des pieds en métal. La composition est complétée par le meuble haut avec des portes en aluminium couleur noir mat avec une vitre en verre fumé.



# BLUES

4.03

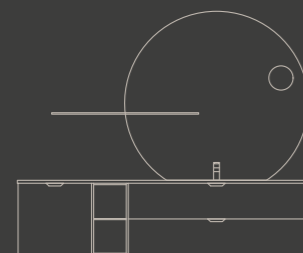

L. 198 cm - P. 50,4 cm - H. 200 cm

Basi / Vanities / Meubles  
Cassa e frontali / Structure and doors / Caisson et façades  
Laccato Porfido Opaco  
Porphyry Matt Lacquered  
Laqué Porphyre Mat

Base a giorno / Open base unit / Base à jour  
Laccato Porfido Opaco  
Porphyry Matt Lacquered  
Laqué Porphyre Mat

Maniglie / Handles / Poignées  
Craft - Laccato Porfido Opaco  
Craft - Porphyry Matt Lacquered  
Craft - Laqué Porphyre Mat

Specchio / Mirror / Miroir  
Sunset + Specchio ingranditore  
Sunset + Make-up Mirror  
Sunset + Miroir Grossissant

Mensola / Shelf / Étagère  
Mensola luminosa  
Lightened shelf  
Étagère éclairée

Top / Top / Plan de Toilette  
Gres - Ossido Nero - Fessura 70  
Gres - Black Oxide - Fessura 70  
Gres - Oxyde Noir - Fessura 70





# BLUES

4.03

IT. Innovativa, originale, sorprendente è la nuova idea di Blues, con la minimale ma funzionale maniglia Craft laccata in tono con le ante. L'immagine della mensola luminosa riempie lo spazio di energia riflessa dalla grande specchiera circolare Sunset retroilluminata.

EN. Innovative, original, surprising are the words that best describe the new Blues idea, with the minimalist yet functional Craft lacquered handle that matches the doors. The image of the illuminated shelf fills the space with energy reflected by the large backlit Sunset circular mirror.

FR. La nouvelle idée de Blues est innovante, originale, surprenante avec la poignée, minimaliste mais fonctionnelle, Craft laquée de la même couleur que les portes. L'image de l'étagère lumineuse remplit l'espace d'énergie réfléchi par le grand miroir circulaire Sunset rétroéclairé.





# BLUES

4.04

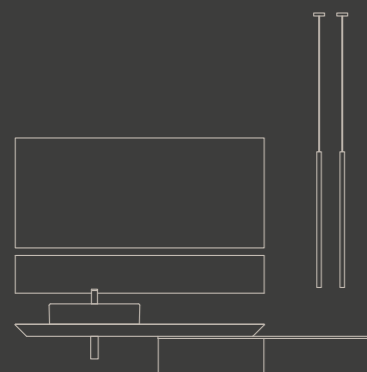

L. 235 cm - P. 50.4 cm - H. 195 cm

Basi / Vanities / Meubles  
Cassa e frontali / Structure and doors / Caisson et façades  
Laccato Tortora Scuro  
Dark Dove Lacquered  
Tourterelle Foncé Mat

Specchio / Mirror / Miroir  
 Rettangolare + Strip Led  
 Rettangolare + Strip Led  
 Rettangolare + Strip Led

Lampada / Lamp / Lampe  
Cilindrica  
Cilindrica  
Cilindrica

Top / Top / Plan de Toilette  
Legno Massello Antico - Edon Tabacco  
Old Wood - Edon Tobacco  
Bois Massif Antique - Edon Tabac

Lavabo / Washbasin / Lavabo  
Tecnoril - Bianco - Square  
Tecnoril - White - Square  
Tecnoril - Blanc - Square



# BLUES

4.04

IT. Una composizione da immaginare e comporre liberamente, accostando alla tavola di legno massello Edon Tabacco con taglio a 45° preziose laccature con tonalità naturali e nuovi colori di tendenza. Raffinato è il gioco di luci dei due grandi specchi retroilluminati che scaldano l'atmosfera.

EN. A composition to be imagined and created freely by combining the Edon Tabacco solid wood table cut at 45° with precious lacquers with natural shades and new trendy colours. The play of light of the two large backlit mirrors that warm the atmosphere adds a refined touch.

FR. Une composition à imaginer et à composer librement, en associant au plan en bois massif Edon Tabacco chanfreiné à 45° de précieux laquages avec des tons naturels et de nouvelles couleurs tendances. Le jeu de lumières raffiné des deux grands miroirs rétroéclairés réchauffe l'atmosphère.





# BLUES

4.05

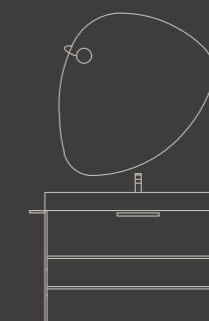

L. 134.2 cm - P. 45.4 cm - H. 205 cm

Basi / Vanities / Meubles  
Cassa e frontali / Structure and doors / Caisson et façades  
Laccato Cipria Opaco  
Powder Pink Matt Lacquered  
Laqué Poudre Mat

Maniglie / Handles / Poignées  
Trendy - Titanio Metallizzato  
Trendy - Metallic Titanium  
Trendy - Titane Métallisé

Specchio / Mirror / Miroir  
Ciottolo  
Ciottolo  
Ciottolo

Lampada / Lamp / Lampe  
Tonda  
Tonda  
Tonda

Top / Top / Plan de Toilette  
Tecnoril - Bianco - Fessura 60  
Tecnoril - White - Fessura 60  
Tecnoril - Blanc - Fessura 60

Elementi metallici / Metal elements / Éléments métalliques  
Alluminio - Titanio Metallizzato  
Aluminium - Metallic Titanium  
Aluminium - Titane Métallisé

# BLUES

4.05

## LE SUPERFICI DEL BENESSERE

**IT.** La purezza del disegno e la forma essenziale generano composizioni originali: un sorprendente gioco di forme arricchite dalla maniglia Trendy e da strutture metalliche in colore titanio abbinato alla laccatura di colore cipria per un sapore anni Cinquanta.

**EN.** The purity of the design and the essential shape create into original compositions: a surprising play of forms enriched by the Trendy handle and metal structures painted in titanium combined with light dusty pink lacquer reminiscent of the Fifties.

**FR.** La pureté du dessin et la forme essentielle génèrent des compositions originales : un jeu surprenant de formes enrichies par la poignée Trendy et par des structures métalliques de couleur titane associée au laquage de couleur poudre pour un style années Cinquante.



# BLUES

4.06

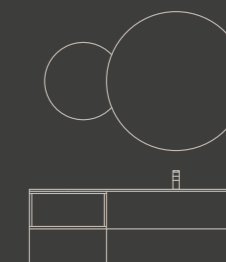

L. 141 cm - P. 50.4 cm - H. 200 cm

Basi / Vanities / Meubles  
Cassa e frontali / Structure and doors / Caisson et façades  
Essenza Olmo Grigio  
Essence Grey Elm  
Bois Orme Gris

Specchio / Mirror / Miroir  
Bubble2  
Bubble2  
Bubble2

Top / Top / Plan de Toilette  
Cristallo Satinato - Bianco Neve - Box 70  
Satin Glass - White Snow - Box 70  
Verre Satiné - Blanc Neige - Box 70

Elementi metallici / Metal elements / Éléments métalliques  
Metallo - Nero Opaco  
Metal - Black Matt  
Métal - Noir Mat



# BLUES

4.06

**IT.** Blues è abbinamento di colori, superfici e materiali diversi. Le finiture ricreano le sensazioni naturali del legno. Pratici vani a giorno di struttura metallica aggiungono funzionalità e ulteriori possibilità compositive.

**EN.** Blues is a combination of different colours, surfaces and materials. The finishes recreate the natural sensations of wood. Practical open compartments in metal structure add functionality and further compositional possibilities.

**FR.** Blues est association de couleurs, surfaces et matériaux différents. Les finitions recréent les sensations naturelles du bois. Des niches ouvertes très pratiques à structure métallique ajoutent des fonctionnalités et des possibilités de composition supplémentaires.





# BLUES

4.07

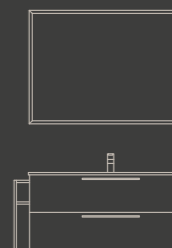

L. 115.8 cm - P. 51.5 cm - H. 190 cm

Basi / Vanities / Meubles  
Cassa e frontali / Structure and doors / Caisson et façades  
Laccato Grigio Efeso Opaco  
Efeso Grey Matt Lacquered  
Laqué Gris Efeso Mat

Maniglie / Handles / Poignées  
Trendy - Nero opaco  
Trendy - Black Matt  
Trendy - Noir Mat

Specchio / Mirror / Miroir  
Lead 2 - Nero Opaco  
Lead 2 - Black Matt  
Lead 2 - Noir Mat

Consolle / Consolle / Console  
Ceramica - Bianco Opaco - Swipe 1V  
Ceramic - White Matt - Swipe 1V  
Céramique - Blanc Mat - Swipe 1V

Elementi metallici / Metal elements / Éléments métalliques  
Alluminio - Nero Opaco  
Aluminium - Black Matt  
Aluminium - Noir Mat





# BLUES

4.08

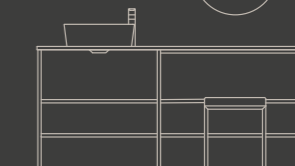
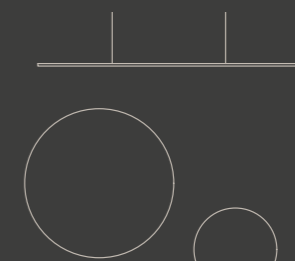

L. 174.8 cm - P. 45.3 cm - H. 205 cm

Basi / Vanities / Meubles  
Cassa / Structure / Caisson  
Essenza Noce Arso  
Burnt Walnut Essence  
Bois Noyer Brûlé  
Frontali / Doors / Façades  
Gres - Pietra Piasentina Taupe Opaco  
Gres - Matt Taupe Piasentina Stone  
Gres - Pierre Piasentina Taupe Mat

Maniglie / Handles / Poignées  
Craft - Nero Opaco  
Craft - Black Matt  
Craft - Noir Mat

Specchio / Mirror / Miroir  
Tonda + Strip led  
Tonda + Strip led  
Tonda + Strip led

Lampada / Lamp / Lampe  
Retta  
Retta  
Retta

Top / Top / Plan de Toilette  
Gres - Pietra Piasentina Taupe Opaco  
Gres - Mat Taupe Piasentina Stone  
Gres - Pierre Taupe Mat

Lavabo / Washbasin / Lavabo  
Tecnoril - Bianco - Omni 387  
Tecnoril - White - Omni 387  
Tecnoril - Blanc - Omni 387

Elementi metallici / Metal elements / Éléments métalliques  
Metallo - Nero Opaco  
Metal - Black Matt  
Métal - Noir Mat



**IT.** Un semplice lavabo d'appoggio. È l'elemento attorno al quale ruotano molteplici possibilità di composizione e organizzazione. Qui Blues si trasforma e rende unica l'architettura. La struttura diventa contenitore con una postazione per il trucco, il tutto dedicato a bellezza e armonia.

**EN.** A simple free-standing countertop washbasin. It is the element around which multiple compositional and organizational possibilities revolve. It is here that Blues transforms itself and turns architecture into something unique. The structure becomes a container with a make-up station, all dedicated to beauty and harmony.

**FR.** Une simple vasque à poser. C'est l'élément autour duquel tournent de multiples possibilités de composition et d'organisation. Ici, Blues se transforme et rend unique l'architecture. La structure devient un rangement avec un coin pour le maquillage, le tout dédié à la beauté et à l'harmonie.



# BLUES

4.09

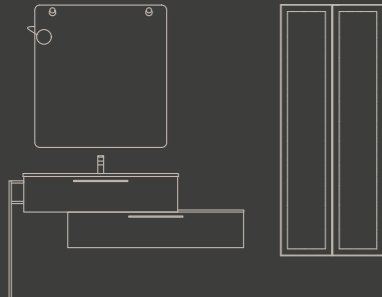

L. 160.2 cm - P. 50.4 cm - H. 200 cm

Basi / Vanities / Meubles  
Cassa e frontali / Structure and doors / Caisson et façades  
Essenza Noce Arso  
Burnt Walnut Essence  
Bois Noyer Brûlé

Maniglie / Handles / Poignées  
Trendy - Nero Opaco  
Trendy - Black Matt  
Trendy - Noir Mat

Colonne / Tall units / Colonnes  
Cassa / Structure / Caisson  
Essenza Noce Arso  
Burnt Walnut Essence  
Bois Noyer Brûlé  
Frontali / Doors / Façades  
Alluminio Nero Opaco con vetro Fumé  
Black Matt Aluminium with smoky glass  
Aluminium Noir Mat avec verre Fumé

Specchio / Mirror / Miroir  
Hook  
Hook  
Hook

Lampada / Lamp / Lampe  
Tonda  
Tonda  
Tonda

Consolle / Consolle / Console  
Gelcrill - Bianco Opaco - Cover 1V  
Gelcrill - White Matt - Cover 1V  
Gelcrill - Blanc Mat - Cover 1V

Elementi metallici / Metal elements / Éléments métalliques  
Metallo - Nero Opaco  
Metal - Black Matt  
Métal - Noir Mat



IT. Anche le composizioni più semplici trovano nei dettagli la qualità raffinata di questa collezione: ricercate soluzioni formali, ammorbidiscono le linee. Piccoli accorgimenti tecnici impreziosiscono la collezione e gli accessori interni arricchiscono di funzioni il mobile, tendendo il tutto a elevare Blues verso l'eccellenza.

EN. The refined quality of this collection is showcased by even the simplest compositions in which the exquisite formal solutions translate into soft lines. Small technical solutions embellish the collection and the internal accessories add functions to the piece of furniture, elevating Blues towards excellence.

FR. Les compositions les plus simples trouvent elles-aussi dans les détails la qualité raffinée de cette collection : des solutions formelles recherchées adoucissent les lignes. De petits éléments techniques agrémentent la collection et les accessoires intérieurs enrichissent le meuble de fonctions, le tout aidant à élever Blues vers l'excellence.

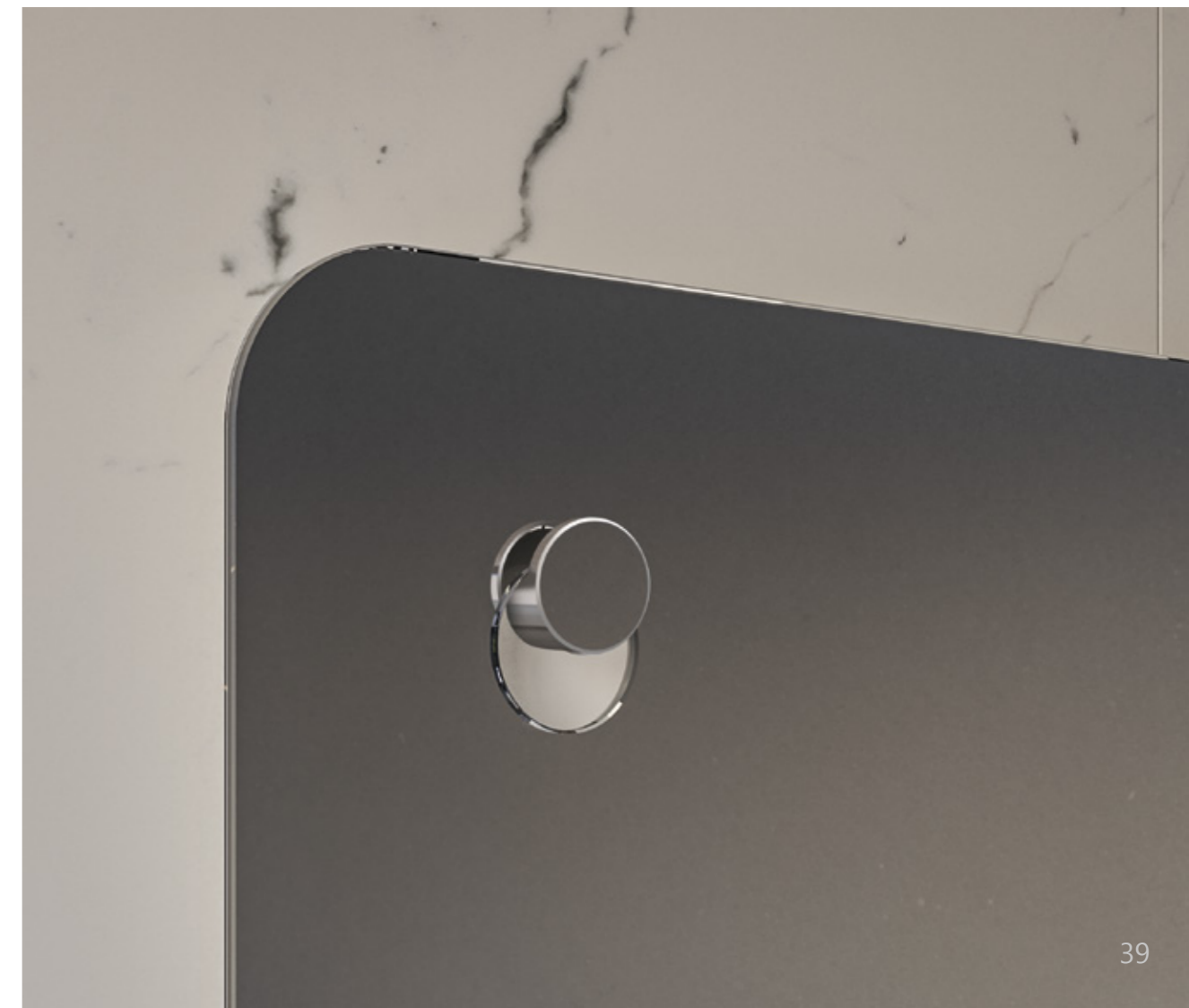

# BLUES

4.10

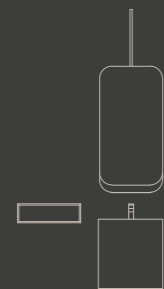

L. 50 + 50 cm - P. 49.5 cm - H. 210 cm

Colonne / Tall units / Colones  
Cassa / Structure / Caisson  
Essenza Noce Arso  
Burnt Walnut Essence  
Bois Noyer Brûlé  
Frontali / Doors / Façades  
Alluminio Nero Opaco con vetro Fumé  
Black Matt Aluminium with smoky glass  
Aluminium Noir Mat avec verre Fumé

Specchio / Mirror / Miroir  
Pole  
Pole  
Pole

Lavabo / Washbasin / Lavabo  
Tecnoril - Bianco - Funky  
Tecnoril - White - Funky  
Tecnoril - Blanc - Funky

Elementi metallici / Metal elements / Éléments métalliques  
Metallo - Nero Opaco  
Metal - Black Matt  
Métal - Noir Mat



# BLUES

4.10

VIVERE  
IN  
LIBERTA'

**IT.** Stimolanti soluzioni innovative e funzionali per piccoli ambienti bagno; nascono soluzioni per ogni esigenza da vivere in libertà godendo dell'eleganza formale insita nella collezione Blues. Prenditi il tuo tempo, tutto è pensato per il benessere e per gli attimi di relax lontani dal caos quotidiano.

**EN.** Stimulating innovative and functional solutions for small bathrooms; any need is met through a solution that allows enjoying in total freedom the formal elegance that characterizes the Blues collection. Take your time, everything is designed for well-being and moments of relaxation away from everyday chaos..

**FR.** Des solutions innovantes et fonctionnelles stimulantes pour les petites salles de bain ; c'est la naissance de solutions pour chaque exigence à vivre en liberté en profitant de l'élégance formelle intrinsèque de la collection Blues. Prenez votre temps, tout est pensé pour le bien-être et pour les moments de détente à l'abri du chaos quotidien.



# BLUES

4.11

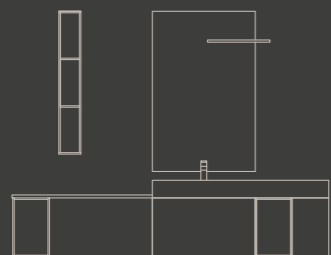

L. 215.5 cm - P. 50.4 cm - H. 200 cm

Basi / Vanities / Meubles  
Cassa e frontali / Structure and doors / Caisson et façades  
Laccato Cloud Opaco  
Cloud Matt Lacquered  
Laqué Nuage Mat

Base a giorno / Open base unit / Base à jour  
Laccato Cloud Opaco  
Cloud Matt Lacquered  
Laqué Nuage Mat

Specchio / Mirror / Miroir  
 Rettangolare  
 Rettangolare  
 Rettangolare

Lampada / Lamp / Lampe  
Half  
Half  
Half

Top / Top / Plan de Toilette  
Gres - Pietra Grey - Fessura 55  
Gres - Grey Stone - Fessura 55  
Gres - Pierre Gris - Fessura 55

Elementi metallici / Metal elements / Éléments métalliques  
Metallo - Nero Opaco  
Metal - Black Matt  
Métal - Noir Mat



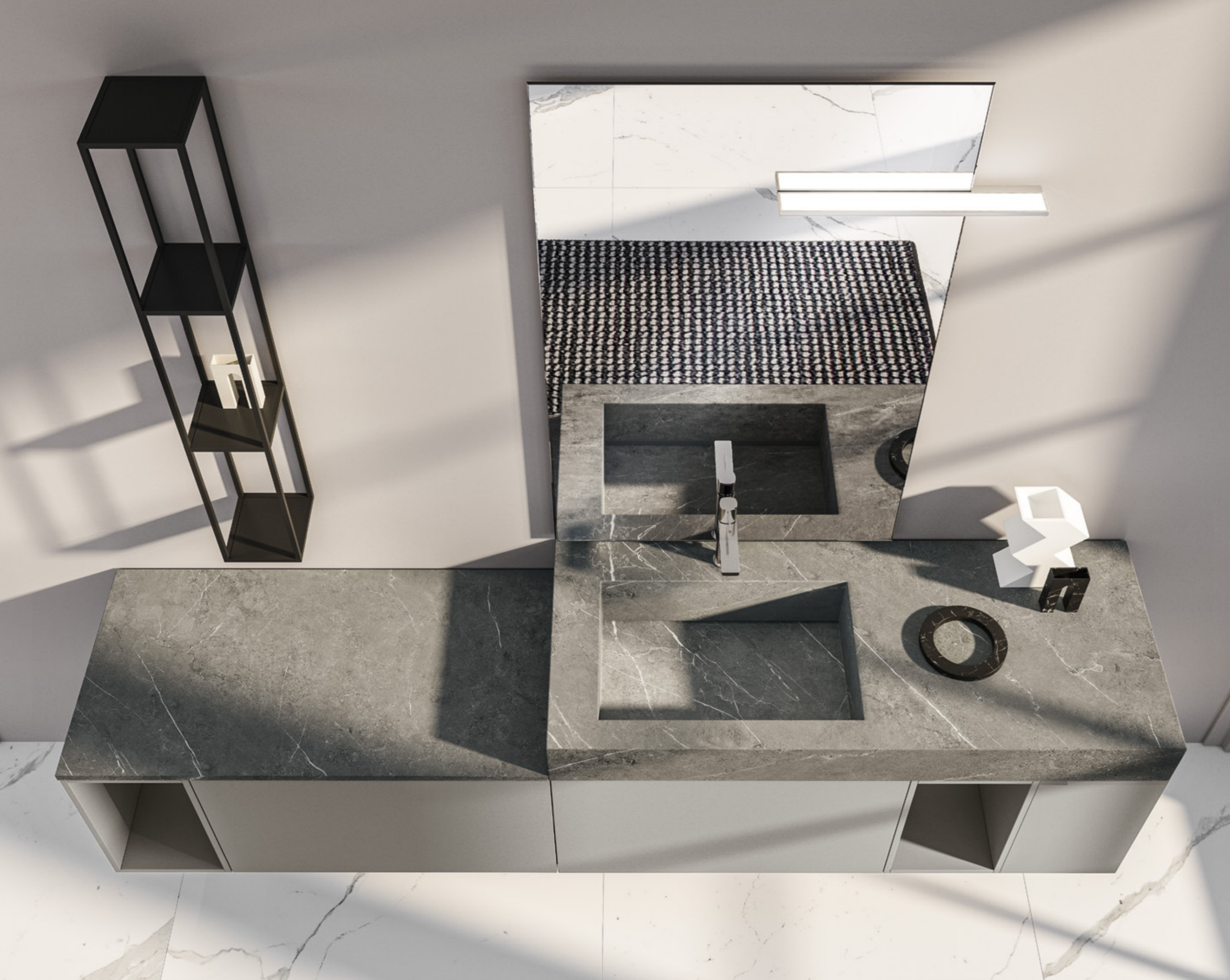

# BLUES

4.11

**IT.** Creatività e rigore: l'eleganza delle venature del materiale dei top in Pietra Grey, in abbinamento al gioco di pieno e di vuoti donano a questa proposta una grande unicità formale, arricchita dalla verticalità dello specchio e del pensile in metallo.

**EN.** Creativity and rigour: the elegant veins of the material from which the Pietra Grey countertops are made, combined with the play of full and empty spaces, lend this proposal a great formal uniqueness, enriched by the verticality of the mirror and of the metal wall unit.

**FR.** Créativité et rigueur : l'élégance du veinage du matériau des plans en Pietra Grey, associée au jeu de pleins et de vides donnent à cette proposition d'une grande singularité de formes, enrichie de la verticalité du miroir et du meuble haut en métal.





# BLUES

4.12

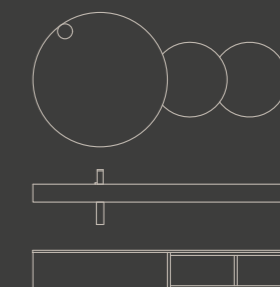

L. 180,4 cm - P. 50,4 cm - H. 200 cm

Basi / Vanities / Meubles  
Cassa e frontali / Structure and doors / Caisson et façades  
Laccato Bianco Opaco  
White Matt Lacquered  
Laqué Blanc Mat

Specchio / Mirror / Miroir  
Bubble3  
Bubble3  
Bubble3

Lampada / Lamp / Lampe  
Tonda Attacco a Specchio  
Tonda Attacco a Specchio  
Tonda Attacco a Specchio

Top / Top / Plan de Toilette  
Gres - Bianco Calacatta Opaco - Fessura 70  
Gres - Calacatta White Matt - Fessura 70  
Gres - Blanc Calacatta Mat- Fessura 70

Elementi metallici / Metal elements / Éléments métalliques  
Metallo - Nero Opaco  
Metal - Black Matt  
Métal - Noir Mat



**IT.** Nuovo è il concetto dell'arredare, elementi di grande pregio sono da mostrare, non più nascondere. Gli spazi interagiscono con gli altri ambienti della casa: specchi in sovrapposizione, strutture metalliche aperte, strip led, accessori, vasche, completano l'ambiente bagno nelle sue innumerevoli varianti.

**EN.** A new idea of furnishing, in which elements of great value are to be showcased and no longer hidden. The spaces interact with the other rooms of the house: overlapping mirrors, open metal structures, LED strips, accessories, and bathtubs complement the bathroom environment in its countless variations.

**FR.** Le concept d'ameublement est nouveau, les éléments de grande valeur sont à montrer, non plus à cacher. Les espaces interagissent avec les autres pièces de la maison : miroirs superposés, structures métalliques ouvertes, bandes LED, accessoires, baignoires, complètent la salle de bain dans ses innombrables variantes.



# BLUES

4.13

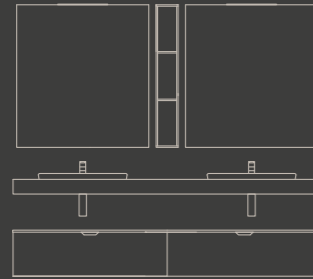

L. 210.4 cm - P. 50.4 cm - H. 200 cm

Basi / Vanities / Meubles  
Cassa / Structure / Caisson  
Laccato Bianco Opaco  
White Matt Lacquered  
Laqué Blanc Mat  
Frontali / Doors / Façades  
Legno Massello Antico - Quercia  
Old Wood - Oak  
Bois Massif Antique - Chêne

Maniglie / Handles / Poignées  
Craft - Laccato Bianco Opaco  
Craft - White Matt Lacquered  
Craft - Laqué Blanc Mat

Specchio / Mirror / Miroir  
 Rettangolare  
 Rettangolare  
 Rettangolare

Lampada / Lamp / Lampe  
Luxury34  
Luxury34  
Luxury34

Top / Top / Plan de Toilette  
Legno Massello Antico - Quercia  
Old Wood - Oak  
Bois Massif Antique - Chêne

Lavabo / Washbasin / Lavabo  
Ceramica - Bianco Lucido - Dandy Rub  
Ceramic - White Glossy - Dandy Rub  
Céramique - Blanc Brillant - Dandy Rub

Elementi metallici / Metal elements / Éléments métalliques  
Alluminio - Titanio Metallizzato  
Aluminium - Metallic Titanium  
Aluminium - Titane Métallisé



IT. Il lavabo a semincasso si integra e allo stesso tempo emerge dal volume della tavola in legno massello Quercia Antica. Si susseguono giochi e rapporti reciproci fra linee e volumi, elementi diversi che si accostano liberamente in una personale ricerca di equilibrio e di originalità.

EN. The semi-recessed washbasin integrates with and at the same time emerges from the volume of the table in Quercia Antica solid wood. Lines and volumes play and interact with each other: different elements that come together freely in a personal search for balance and originality.

FR. La vasque semi-encastrable s'intègre et ressort en même temps du volume du plan en bois massif Quercia Antica. Des jeux et rapports réciproques se succèdent entre lignes et volumes, des éléments différents s'associent librement dans une recherche personnelle d'équilibre et d'originalité.



# BLUES

4.14

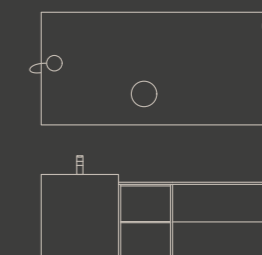

L. 155.2 cm - P. 49.5 cm - H. 190 cm

Basi / Vanities / Meubles  
Cassa e frontali / Structure and doors / Caisson et façades  
Laccato Bianco Opaco  
White Matt Lacquered  
Laqué Blanc Mat

Base a giorno / Open base unit / Base à jour  
Essenza Noce Crudo  
Raw Walnut Essence  
Bois Noyer Brut

Specchio / Mirror / Miroir  
 Rettangolare + Specchio ingranditore  
 Rettangolare + Make-up Mirror  
 Rettangolare + Miroir Grossissant

Lampada / Lamp / Lampe  
Tonda  
Tonda  
Tonda

Top / Top / Plan de Toilette  
Laccato Bianco Opaco  
White Matt Lacquered  
Laqué Blanc Mat

Lavabo / Washbasin / Lavabo  
Tecnoril - Bianco - Funky  
Tecnoril - White - Funky  
Tecnoril - Blanc - Funky

# BLUES

4.15

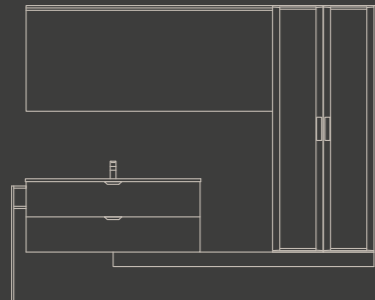

L. 250 cm - P. 50.4 cm - H. 204.5 cm

Basi / Vanities / Meubles  
Cassa e frontali / Structure and doors / Caisson et façades  
Laccato Fondente Opaco  
Dark Chocolate Matt Lacquered  
Laqué Chocolat noir Mat

Colonne / Tall units / Colonne  
Cassa / Structure / Caisson  
Laccato Fondente Opaco  
Dark Chocolate Matt Lacquered  
Laqué Chocolat noir Mat  
Frontali / Doors / Façades  
Alluminio Titanio Metallizzato con vetro Bronze  
Metallic Titanium Aluminium with Bronze glass  
Aluminium Titane Métallisé avec verre Bronze

Maniglie / Handles / Poignées  
Craft - Titanio Metallizzato  
Craft - Metallic Titanium  
Craft - Titane Métallisé

Specchio / Mirror / Miroir  
 Rettangolare  
 Rettangolare  
 Rettangolare

Lampada / Lamp / Lampe  
 Trial  
 Trial  
 Trial

Top / Top / Plan de Toilette  
Gres - Ceppo di Gré Bocciardato Grigio Opaco - Fessura 70  
Gres - Matt Grey Ceppo di Gré Bocciardato - Fessura 70  
Gres - Ceppo di Gré Bocciardato Gris Mat - Fessura 70

Top in legno / Wooden Top / Plan en bois  
Legno Massello Antico - Edon Tabacco  
Old Wood - Edon Tobacco  
Bois Massif Antique - Edon Tabac

Elementi metallici / Metal elements / Éléments métalliques  
Alluminio - Titanio Metallizzato  
Aluminium - Metallic Titanium  
Aluminium - Titane Métallisé





**IT.** L' essenzialità delle forme e la ricercatezza dei materiali sono elementi distintivi del sistema Sound, valorizzati da forme lineari ed elementi componibili che consentono soluzioni compositive evolute.

**EN.** The essential shapes and the refined materials are the distinctive elements of the Sound system, enhanced by linear shapes and modular elements that allow refined compositional solutions.

**FR.** Le caractère essentiel des formes et le caractère recherché extrême des matériaux sont des éléments distinctifs du système Sound, mis en valeur par des formes linéaires et des éléments composables qui permettent de créer des compositions innovantes.





# BLUES

4.16

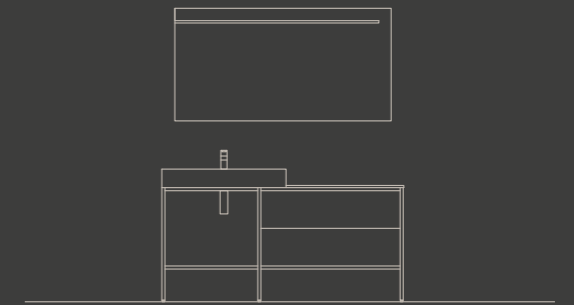

L. 156.8 cm - P. 45.4 cm - H. 190 cm

Basi / Vanities / Meubles  
Cassa e frontali / Structure and doors / Caisson et façades  
Laccato Carta da Zucchero Opaco  
Powder Blue Matt Lacquered  
Laqué Bleu Poudre Mat

Specchio / Mirror / Miroir  
Inside  
Inside  
Inside

Consolle / Consolle / Console  
Deikon - Bianco - Figura  
Deikon - White - Figura  
Deikon - Blanc - Figura

Elementi metallici / Metal elements / Éléments métalliques  
Alluminio - Nero Opaco  
Aluminium - Black Matt  
Aluminium - Noir Mat





**IT.** Innovazione, tendenza, design, moda: Blues esprime in tutte le sue varianti la capacità di essere contemporaneo. Sempre diverso, dinamico, imprevedibile, capace di essere un concept d'arredo bagno totale permettendo una maggiore fruibilità degli spazi, pensato per durare nel tempo e per tutte le fasce di età con il suo lavabo in deikon.

**EN.** Innovation, trend, design, fashion: Blues expresses its contemporary vocation in all its variations. Different, dynamic, unpredictable, this is a total bathroom furnishing concept that allows greater usability of spaces and has been designed to last over time and to perfectly suit all age groups, thanks to its deikon washbasin.

**FR.** Innovation, tendance, design, mode : Blues exprime dans toutes ses variantes la capacité d'être contemporain. Toujours différent, dynamique, imprévisible, il est capable d'être un concept d'ameublement de salle de bain offrant une plus grande utilisation des espaces, pensé pour durer dans le temps et pour toutes les tranches d'âge avec sa vasque en deikon.



# BLUES

4.17

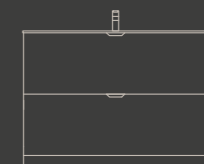
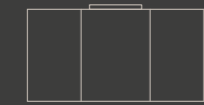

L. 121 cm - P. 50.4 cm - H. 190 cm

Basi / Vanities / Meubles  
Cassa e frontali / Structure and doors / Caisson et façades  
Laccato Verde Salvia Opaco  
Sage-green Matt Lacquered  
Laqué Vert Saugé Mat

Maniglie / Handles / Poignées  
Craft - Titanio Metallizzato  
Craft - Metallic Titanium  
Craft - Titane Métallisé

Specchio / Mirror / Miroir  
Cont 3 As  
Cont 3 As  
Cont 3 As

Top / Top / Plan de Toilette  
Tecnoril - Bianco - Raggiata 70  
Tecnoril - White - Raggiata 70  
Tecnoril - Blanc - Raggiata 70

# BLUES

4.18

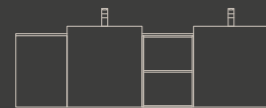

L. 170.2 cm - P. 49.5 cm - H. 190 cm

Basi / Vanities / Meubles  
Cassa e frontali / Structure and doors / Caisson et façades  
Laccato Pomice Opaco  
Pumice Matt Lacquered  
Laqué Ponce Mat

Base a giorno / Open base unit / Base à jour  
Laccato Pomice Opaco  
Pumice Matt Lacquered  
Laqué Ponce Mat

Specchio / Mirror / Miroir  
Scatolata  
Scatolata  
Scatolata

Lavabo / Washbasin / Lavabo  
Tecnoril - Bianco - Funky  
Tecnoril - White - Funky  
Tecnoril - Blanc - Funky





# BLUES

4.18

IT. Pieni e vuoti, contenitori e portalavabi composti a moltiplicare le soluzioni di volumi, la funzionalità e il comfort dell'ambiente, sfruttando tutto lo spazio a disposizione e assecondando ogni movimento. Tutto è pensato al benessere dell'abitare il bagno: dal lavabo Funky contenitore e gli elementi a giorno, alla bellissima specchiera Scatolata.

EN. Full and empty spaces, containers and washbasin holders create compositions that multiply the volumes, the functionality and the comfort of the room, exploiting all the available space and adapting to every movement. Everything is designed around the well-being that is typically associated with the bathroom: from the Funky container washbasin and the open elements, to the beautiful Scatolata mirror.

FR. Les pleins et vides, les rangements et les sous-vasque composés multiplient les solutions de volumes, la fonctionnalité et le confort de la pièce, en utilisant l'espace à disposition et en favorisant chaque mouvement. Tout est pensé pour le bien-être dans la salle de bain : de la vasque monobloc avec rangements Funky et les éléments ouverts, au magnifique miroir Scatolata.



# BLUES

4.19

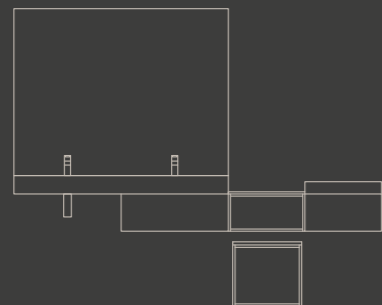

L. 240 cm / 140 cm - P. 50.4 cm - H. 195 cm

Basi / Vanities / Meubles  
Pensili/Wall-unit/Éléments hauts  
Cassa / Structure / Caisson  
Laccato Castoro Ottawa Opaco  
Ottawa Breaver Matt Lacquered  
Laqué Castor Ottawa Mat  
Frontali / Doors / Façades  
Laccato Castoro Ottawa Opaco+Alluminio Titanio Metallizzato con vetro Bronze  
Ottawa Breaver Matt Lacquered+Metallic Titanium Aluminium with Bronze glass  
Laqué Castor Ottawa Mat+Aluminium Titane Métallisé avec verre Bronze

Base a giorno / Open base unit / Base à jour  
Essenza Noce Crudo  
Raw Walnut Essence  
Bois Noyer Brut

Specchio / Mirror / Miroir  
 Rettangolare + Strip Led  
 Rettangolare + Strip Led  
 Rettangolare + Strip Led

Specchio / Mirror / Miroir  
 Rettangolare + Strip Led + Specchio ingranditore  
 Rettangolare + Strip Led + Make-up Mirror  
 Rettangolare + Strip Led + Miroir Grossissant

Lampada / Lamp / Lampe  
Tonda  
Tonda  
Tonda

Top / Top / Plan de Toilette  
Tecnoril - Bianco - Fessura 50  
Tecnoril - White - Fessura 50  
Tecnoril - Blanc - Fessura 50

Top in legno / Wooden Top / Plan en bois  
Essenza Noce Crudo  
Raw Walnut Essence  
Bois Noyer Brut

Elementi metallici / Metal elements / Éléments métalliques  
Alluminio - Titanio Metallizzato  
Aluminium - Metallic Titanium  
Aluminium - Titane Métallisé





# BLUES

4.19

IT. La forza, la natura, la peculiarità di blues è la componibilità: la grande trasversalità degli elementi e dei materiali permettono infatti grande progettualità e capacità organizzative degli spazi, in una filosofia del total Sound space. E allora che ci sia maniglia (collezione Blues) o gola (collezione Swing) "A volte le parole non bastano. E allora servono i colori. E le forme. E le emozioni."

A. Baricco

EN. The strength, nature, and peculiarity of Blues lies in its modularity: the outstanding versatility of the elements and materials allows in fact remarkable planning and organization of the spaces, in line with the total Sound space philosophy. So whether there is a handle (Blues collection) or a groove (Swing collection) "Sometimes words are not enough. And then we need colours. And shapes. And notes. And emotions."

A. Baricco

FR. La force, la nature, la particularité de blues est sa modularité : la grande transversalité des éléments et des matériaux offre en effet une grande possibilité de créer des projets et capacité d'organiser les espaces, dans une philosophie de total Sound space. Et donc, qu'il y ait une poignée (collection Blues) ou une gorge (collection Swing) « Parfois les mots ne suffisent pas. C'est là qu'interviennent les couleurs. Et les formes. Et les notes. Et les émotions. »

A. Baricco



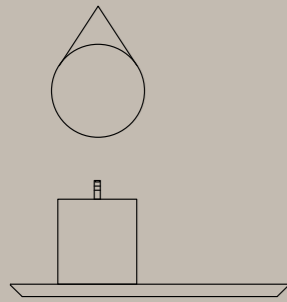

BLUES 4.01 pag 2 - 5

**Dimensioni/ Dimentions/ Dimension**  
larghezza/ lenght/ largeur: cm 180  
profondità/ depth/ profondeur: cm 50.4  
altezza/ height/ hauteur: cm 220

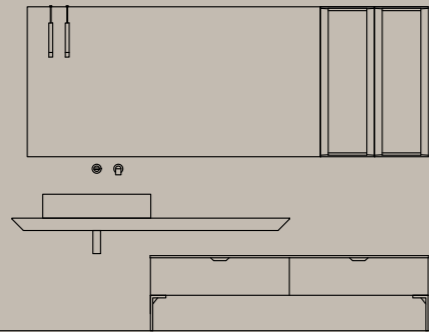

BLUES 4.02 pag 6 - 11

**Dimensioni/ Dimentions/ Dimension**  
larghezza/ lenght/ largeur: cm 270  
profondità/ depth/ profondeur: cm 50.4  
altezza/ height/ hauteur: cm 210

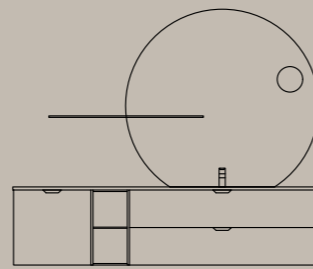

BLUES 4.03 pag 12 - 15

**Dimensioni/ Dimentions/ Dimension**  
larghezza/ lenght/ largeur: cm 198  
profondità/ depth/ profondeur: cm 50.4  
altezza/ height/ hauteur: cm 200

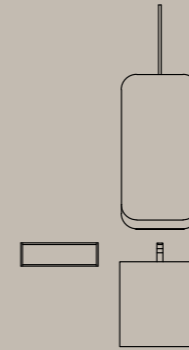

BLUES 4.10 pag 40 - 43

**Dimensioni/ Dimentions/ Dimension**  
larghezza/ lenght/ largeur: cm 50 + 50  
profondità/ depth/ profondeur: cm 49.5  
altezza/ height/ hauteur: cm 210

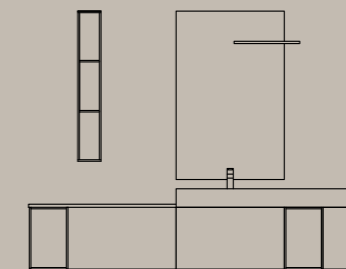

BLUES 4.11 pag 44 - 47

**Dimensioni/ Dimentions/ Dimension**  
larghezza/ lenght/ largeur: cm 215.5  
profondità/ depth/ profondeur: cm 50.4  
altezza/ height/ hauteur: cm 200

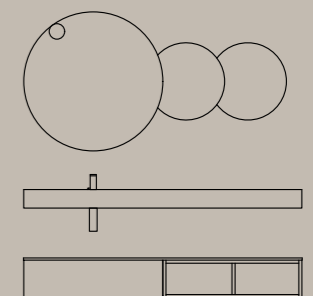

BLUES 4.12 pag 48 - 51

**Dimensioni/ Dimentions/ Dimension**  
larghezza/ lenght/ largeur: cm 180.4  
profondità/ depth/ profondeur: cm 50.4  
altezza/ height/ hauteur: cm 200

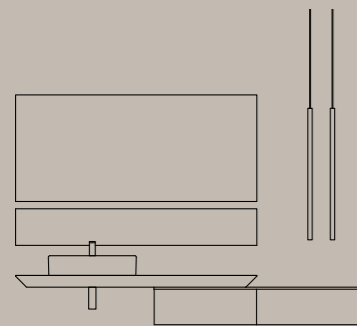

BLUES 4.04 pag 16 - 19

**Dimensioni/ Dimentions/ Dimension**  
larghezza/ lenght/ largeur: cm 235  
profondità/ depth/ profondeur: cm 50.4  
altezza/ height/ hauteur: cm 195

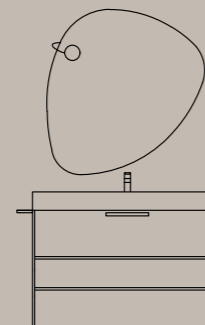

BLUES 4.05 pag 20 - 23

**Dimensioni/ Dimentions/ Dimension**  
larghezza/ lenght/ largeur: cm 134.2  
profondità/ depth/ profondeur: cm 45.4  
altezza/ height/ hauteur: cm 205

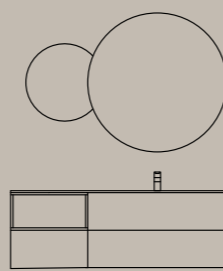

BLUES 4.06 pag 24 - 27

**Dimensioni/ Dimentions/ Dimension**  
larghezza/ lenght/ largeur: cm 141  
profondità/ depth/ profondeur: cm 50.4  
altezza/ height/ hauteur: cm 200

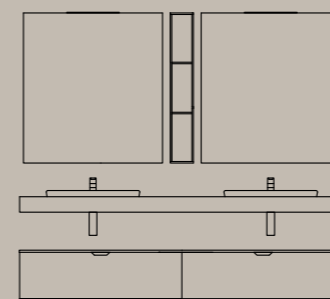

BLUES 4.13 pag 52 - 55

**Dimensioni/ Dimentions/ Dimension**  
larghezza/ lenght/ largeur: cm 210.4  
profondità/ depth/ profondeur: cm 50.4  
altezza/ height/ hauteur: cm 200

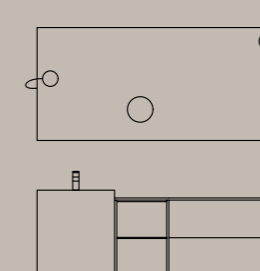

BLUES 4.14 pag 56 - 57

**Dimensioni/ Dimentions/ Dimension**  
larghezza/ lenght/ largeur: cm 155.2  
profondità/ depth/ profondeur: cm 49.5  
altezza/ height/ hauteur: cm 190

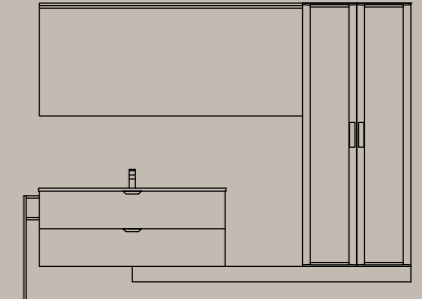

BLUES 4.15 pag 58 - 61

**Dimensioni/ Dimentions/ Dimension**  
larghezza/ lenght/ largeur: cm 250  
profondità/ depth/ profondeur: cm 50.4  
altezza/ height/ hauteur: cm 204.5

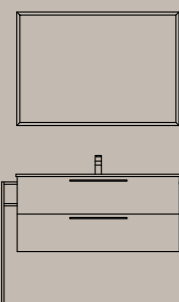

BLUES 4.07 pag 28 - 31

**Dimensioni/ Dimentions/ Dimension**  
larghezza/ lenght/ largeur: cm 115.8  
profondità/ depth/ profondeur: cm 51.5  
altezza/ height/ hauteur: cm 190

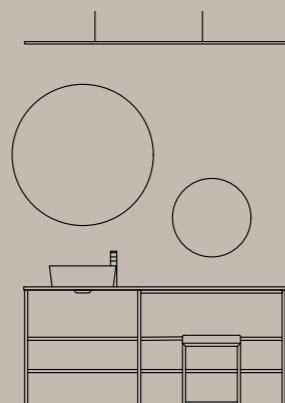

BLUES 4.08 pag 32 - 35

**Dimensioni/ Dimentions/ Dimension**  
larghezza/ lenght/ largeur: cm 174.8  
profondità/ depth/ profondeur: cm 45.3  
altezza/ height/ hauteur: cm 205

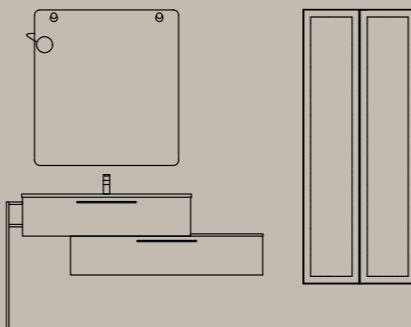

BLUES 4.09 pag 36 - 39

**Dimensioni/ Dimentions/ Dimension**  
larghezza/ lenght/ largeur: cm 160.2  
profondità/ depth/ profondeur: cm 50.4  
altezza/ height/ hauteur: cm 200

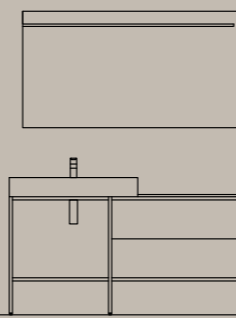

BLUES 4.16 pag 62 - 65

**Dimensioni/ Dimentions/ Dimension**  
larghezza/ lenght/ largeur: cm 156.8  
prof./ depth/ profondeur: cm 45.4  
altezza/ height/ hauteur: cm 190

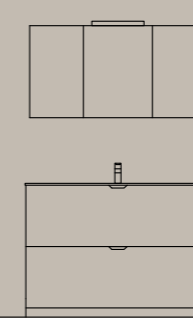

BLUES 4.17 pag 66 - 67

**Dimensioni/ Dimentions/ Dimension**  
larghezza/ lenght/ largeur: cm 121  
prof./ depth/ profondeur: cm 50.4  
altezza/ height/ hauteur: cm 190

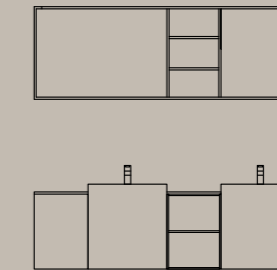

BLUES 4.18 pag 68 - 71

**Dimensioni/ Dimentions/ Dimension**  
larghezza/ lenght/ largeur: cm 170.2  
prof./ depth/ profondeur: cm 49.5  
altezza/ height/ hauteur: cm 190

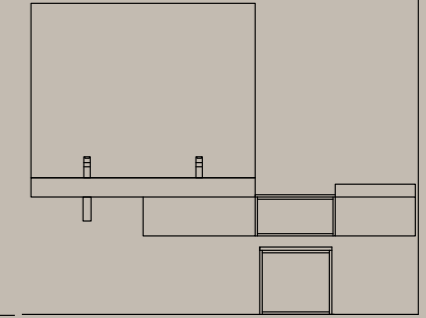

BLUES 4.19 pag 72 - 75

**Dimensioni/ Dimentions/ Dimension**  
larghezza/ lenght/ largeur: cm 240/140  
prof./ depth/ profondeur: cm 50.4  
altezza/ height/ hauteur: cm 195

1	2 - 3	4 - 5	36 - 37	38 - 39	40 - 41	42 - 43
6 - 7	8 - 9	10 - 11	44 - 45	46 - 47	48 - 49	50 - 51
12 - 13	14 - 15	16 - 17	52 - 53	54 - 55	56 - 57	58 - 59
18 - 19	20 - 21	22 - 23	60 - 61	62 - 63	64 - 65	66 - 67
24 - 25	26 - 27	28 - 29	68 - 69	70 - 71	72 - 73	74 - 75
30 - 31	32 - 33	34 - 35	76 - 77	78 - 79	80	



