

CATALISTINO 2023 . IT . EN . FR  
CATALOGUE-PRICE LIST . CATALOGUE-LISTE DES PRIX

HAFRO

# MINI E MAXI SPA

GRUPPO GEROMIN  
VENEZIA 1945

HAFRO

Mondi di grande  
benessere, dove immergere  
il corpo per rilassare  
la mente.

Worlds of great well-being,  
where to immerse the body to relax the mind.

Mondes de grand bien-être,  
où immerger le corps pour détendre l'esprit.



**Gruppo Geromin distributore Wellis**

Gruppo Geromin Wellis supplier  
Gruppo Geromin distributeur pour Wellis

**Mars**

Pag. 22

213 x 160 x 75 cm  
37 jets

A: 2 B: 1

**Pluto**

Pag. 24

200 x 200 x 89 cm  
42 jets

A: 2 B: 3

**Manhattan**

Pag. 26

201 x 153 x 85 cm  
30 jets

A: 1 B: 2

**Prague**

Pag. 28

200 x 200 x 90 cm  
50 jets

A: 1 B: 5

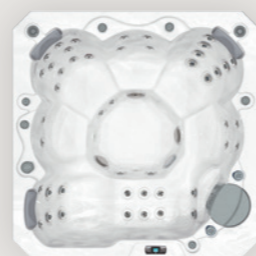
**Budapest**

Pag. 30

200 x 200 x 89 cm  
42 jets

A: 2 B: 3

**Palermo**

Pag. 32

218 x 218 x 90 cm  
42 jets

A: 2 B: 3

**Lugano**

Pag. 34

230 x 230 x 94 cm  
52 jets

A: 1 B: 5

**Danube**

Pag. 36

453 x 235 x 147 cm  
24 jets

B: 2 C: 1



A: Postazioni reclinare  
Reclining places - Places inclinables

B: Postazioni di seduta  
Sitting places - Places assises

C: Postazione per nuoto  
Swimming station - Station de natation

**/index****12 • Caratteristiche tecniche**

Technical features  
Caractéristiques techniques

**Mini-Maxi Spa**

- 22 • Mars
- 24 • Pluto
- 26 • Manhattan
- 28 • Prague
- 30 • Budapest
- 32 • Palermo
- 34 • Lugano
- 36 • Danube

**39 • Colonna doccia Outdoor**

Outdoor shower column - Colonne de douche Outdoor

**40 • Accessori**

Accessories - Accessoires

## La purezza dell'acqua

Water purity - La pureté de l'eau

Tutte le spa utilizzano un sistema di filtraggio e disinfezione a più stadi, che garantisce un'acqua cristallina e pulita con il minimo intervento da parte dell'utente e una purificazione dell'acqua più volte al giorno. La pompa di ricircolo a basso consumo energetico fa circolare l'acqua della spa attraverso i filtri a cartuccia antimicrobici, all'interno dei quali le particelle più piccole vengono intrappolate. Il rivestimento antimicrobico aiuta ad eliminare i batteri, prevenendo la proliferazione e gli odori e assicurando una facile pulizia dei filtri. Tutte le spa inoltre sono dotate di un dispositivo di igienizzazione elettronico che riduce notevolmente la quantità di sostanze chimiche necessarie per la pulizia dell'acqua: è il sistema OZMIX™.

All spas use a multi-stage filtration and sanitation system that ensures crystal clear, safe bathing water with the minimum of user input and its purification several times a day. The energy-saving recirculation pump draws spa water through special antimicrobial cartridge filters where any tiny particles are trapped. The antimicrobial coating then helps to eliminate any bacteria ensuring an easy cleaning of the filters. All spas are also equipped with a special electronic sanitising device that significantly reduces the amount of chemicals needed to clean the water: this is the OZMIX™ system.

Tous les spas utilisent un système de filtration et de désinfection à plusieurs niveaux, qui garantit une eau cristalline et propre avec une intervention minimale de l'utilisateur et une purification de l'eau plusieurs fois par jour. La pompe de recirculation économe en énergie fait circuler l'eau du spa à travers les filtres à cartouche antimicrobiens, où les plus petites particules sont piégées. Le revêtement antimicrobien aide à détruire les bactéries qui peuvent adhérer aux particules filtrées, empêchant ainsi la prolifération et les odeurs et facilitant le nettoyage des filtres. Tous les spas sont également équipés d'un dispositif électronique spécial d'assainissement qui réduit considérablement la quantité de produits chimiques nécessaires pour nettoyer l'eau: il s'agit du système OZMIX™.



### Bocchette a testa rotante

Rotating jets / Jets rotatifs

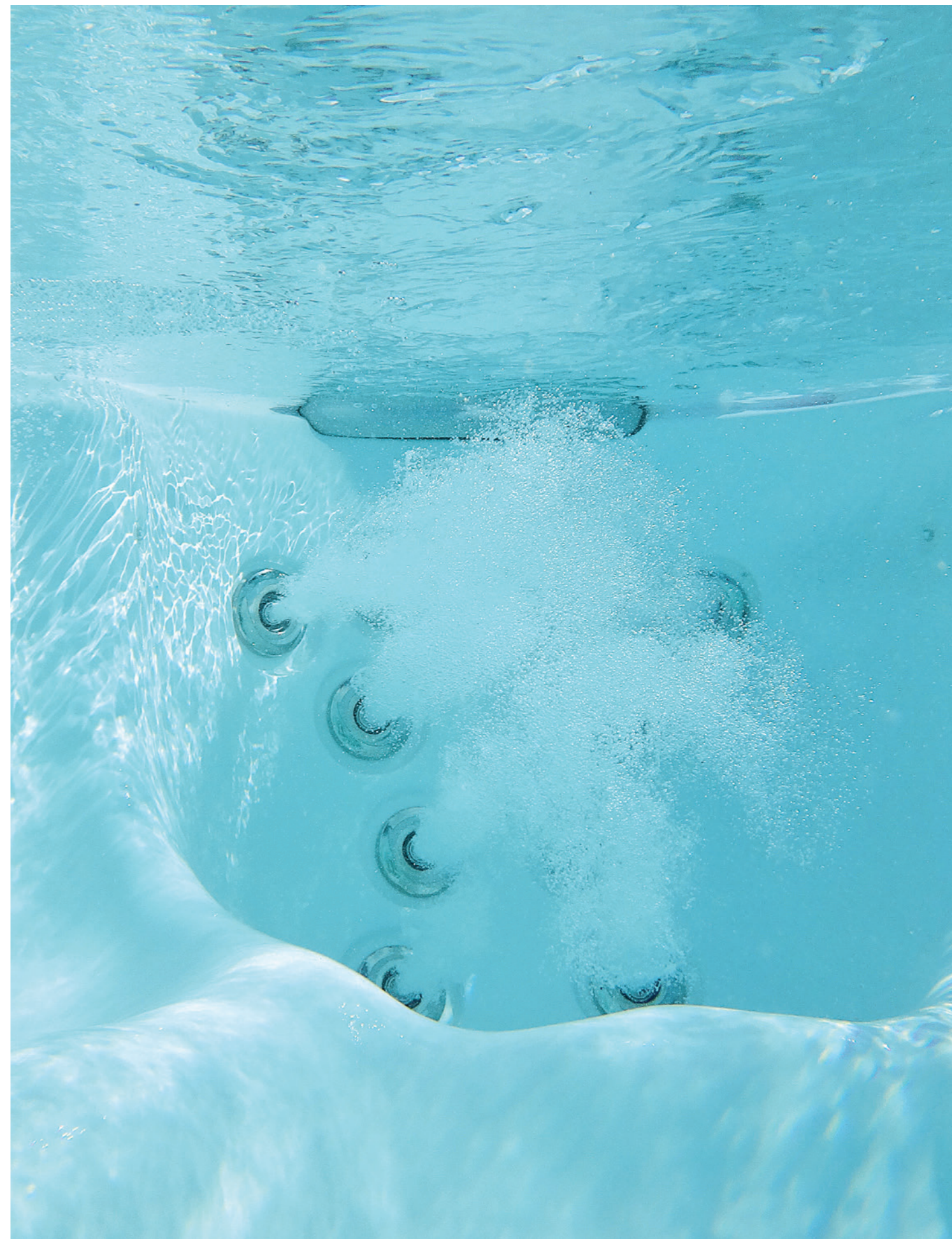

## Postazioni massaggio

Massage stations - Stations de massage



### Postazione di massaggio Relax

Relax massage seat - Station de massage Relax

**Mira alla rigenerazione dei fasci muscolari della cintura scapolare e dei tessuti dei muscoli longitudinali del torace, così come dei muscoli flessori delle anche e dei muscoli estensori del ginocchio.**

It targets the regeneration of the shoulder girdle and the longitudinal trunk muscle tissues, as well as the hip flexor muscles and the knee extensor muscles – the muscle groups most exposed to everyday loads.

Il vise à régénérer les faisceaux musculaires de la ceinture scapulaire et les tissus des muscles longitudinaux du thorax, ainsi que les muscles fléchisseurs de la hanche et extenseurs du genou.

### Postazione di massaggio Expert

Expert massage seat - Station de massage Expert

**Grazie all'ottima regolazione di direzione ed intensità dei getti idromassaggio, questa postazione garantisce un ideale rilassamento dei muscoli di tutta la schiena.**

Thanks to the excellent regulation of hydromassage jets and intensity, this station ensures ideal relaxation of the back muscles.

Grâce à l'excellent réglage de la direction et de l'intensité des jets de massage, cette station garantit une relaxation idéale des muscles du dos.

### Postazione di massaggio Cool Down

Cool Down massage seat - Station de massage Cool Down

**Il design a poltrona garantisce il rilassamento dopo un allenamento ristabilendo le funzioni fisiologiche.**

The armchair design provides relaxation after training; its psychical and calming effect should be mentioned in addition to the recovery of physiological functions.

Le design de la chaise permet de se détendre après une séance d'entraînement en rétablissant les fonctions physiologiques.

### Postazione di massaggio Focus

Focus massage seat - Focus massage seat

**Rilassa i tessuti muscolari longitudinali del tronco, muove in modo passivo i gruppi muscolari flessori ed estensori di anche e cosce.**

Relaxing the longitudinal trunk muscle tissues, and passively exercising the hip and the thigh flexor and extensor muscle groups.

Il détend les tissus musculaires longitudinaux du tronc, déplace passivement les groupes de muscles fléchisseurs et extenseurs des hanches et des cuisses.

### Postazione di massaggio Body Flow

Body Flow massage seat - Station de massage Body Flow

**La postazione di massaggio con l'effetto fisiologico più intenso; oltre alle fibre muscolari del tronco, ha effetti anche sulla circolazione venosa e linfatica degli arti inferiori, portando così sollievo alle valvole venose.**

The massage seat with the most intensive physiological effect; in addition to the trunk's muscle fibers, it also has effects on venous and lymphatic circulation in the lower limbs, in this way bringing relief to vein valves.

La station de massage à l'effet physiologique le plus intense; outre les fibres musculaires du tronc, elle agit également sur la circulation veineuse et lymphatique des membres inférieurs, soulageant ainsi les valvules veineuses.

### Postazione di massaggio Intenso

Intense massage seat - Station de massage Intense

**La postazione di massaggio più effervescente. Dopo un allenamento estenuante e intenso, assicura la rigenerazione delle aree più critiche come i muscoli della schiena e degli arti inferiori.**

The most refreshing massage seat. The favorite of professional athletes. After exhaustive and intensive training, it ensures the regeneration of the most critical areas, the back and leg muscles.

La station de massage la plus effervescente. Après un entraînement épuisant et intense, elle assure la régénération des zones les plus critiques telles que les muscles du dos et des membres inférieurs.

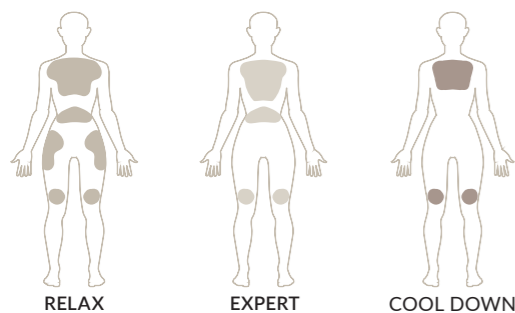

RELAX

EXPERT

COOL DOWN

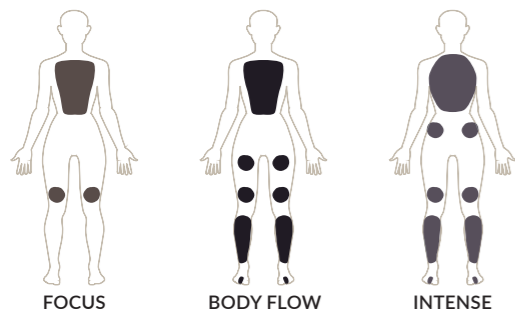

FOCUS

BODY FLOW

INTENSE



### Copertura Termica con sollevatore

Thermo cover with lifter - Couverture thermique avec lève

Copertura termica compresa nel prezzo.

Per optional sollevatore vedi pag. 40.

Thermo cover included in the price.

For optional lifter see page 40.

Couverture thermique incluse dans le prix.

Pour option de levage, voir page 40.





## Danube

*Una spa pensata per poterti allenare direttamente a casa tua.*  
Il sistema di nuoto controcorrente offre il perfetto flusso per esercitarsi liberamente nella spa: 6 diversi programmi permettono di personalizzare gli allenamenti, impostando anche la durata e l'intensità del flusso.

*A spa designed for training at home.*  
The counter-current swimming system provides the perfect flow for exercising freely in the spa: 6 different programmes allow you to customise your workouts, including setting the duration and intensity of the water flow.

*Un spa conçu pour que vous puissiez vous entraîner chez vous.*  
Le système de nage à contre-courant fournit le flux parfait pour s'exercer librement dans le spa : 6 programmes différents vous permettent de personnaliser vos exercices, en réglant même la durée et l'intensité du flux.



**Vogatore per Danube**  
Danube rowing system - Rameur Danube



Danube è inoltre dotata di due sedili ergonomici con postazione idromassaggio che rilassa i tessuti muscolari del tronco.  
Danube is also equipped with two ergonomic seats with hydromassage stations that relax the muscular tissues of the trunk.  
Danube est également équipé de deux sièges ergonomiques avec des stations d'hydromassage qui détendent les tissus musculaires du torse.

▼  
Danube  
collection spa



# Caratteristiche tecniche

Technical features - Caractéristiques techniques

## 1- GUSCIO

Spa shell - Structure

### Struttura del guscio

Spa shell structure - Structure de la minipiscine

- A. **Superficie esterna in materiale acrilico con trattamento antimicrobico.**  
External surface in acrylic material with antimicrobial treatment.  
Surface externe acrylique avec traitement antimicrobien.
- B. **Strato in polimero di ABS per aumentare ulteriormente la robustezza e la resistenza agli urti.**  
ABS polymer layer to further increase strength and impact resistance.  
Couche de polymère ABS pour augmenter la puissance et la résistance aux chocs.
- C. **POLI-MAX™ Poliuretano a media densità con applicazione robotizzata per ulteriore robustezza e isolamento termico e acustico.**  
Medium density polyurethane with robotic application for additional strength and thermal and acoustic insulation.  
Polyuréthane de densité moyenne appliqué par robot pour une plus grande résistance et une isolation acoustique et thermique.

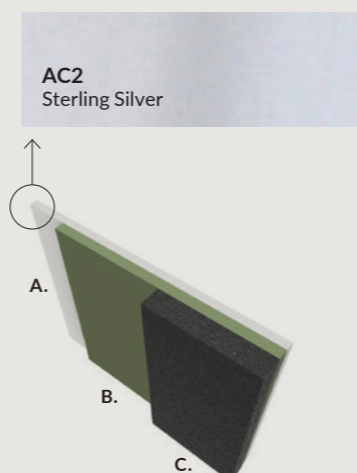

## 2- TELAIO

Frame - Chassis

### Tipologie di telaio disponibili a seconda del modello.

Types of frame available according to the model. - Types de chassis disponibles selon le modèle.



**TELAIO IN LEGNO**  
Wood frame - chassis en bois

Di serie su:  
Standard on - De série sur  
MARS  
PLUTO



**TELAIO IN WPS**  
Wps frame - Chassis en wps

Di serie su:  
Standard on - De série sur  
MANHATTAN  
PRAGUE  
BUDAPEST  
PALERMO  
LUGANO



**TELAIO IN Acciaio**  
Steel frame - chassis en acier

Di serie su:  
Standard on - De série sur  
DANUBE

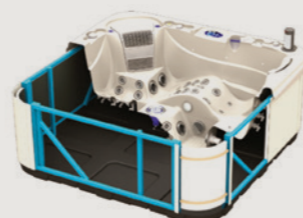

## 3- FONDO SPA

Spa bottom - Fond du spa

### Fondo in abs sagomato, rinforzato e isolato.

Bottom in shaped abs, reinforced and insulated. - Fond en abs façonné, renforcé et isolé.

Il fondo della spa realizzato in ABS rinforzato crea una solida barriera contro umidità e insetti.  
The spa bottom, made of reinforced ABS, creates a barrier against moisture and insects.  
Le fond du spa en ABS renforcé constitue une barrière solide contre l'humidité et les insectes.



## 4- PANNELLI

Spa panels - Panneaux

I pannelli delle spa sono realizzati con un polimero resistente ai raggi UV in finitura legno.

The spa panels are made with a UV resistant polymer in wood finish.

Les panneaux du spa sont fabriqués avec un polymère résistant aux rayons UV dans une finition bois.

S03  
Grey

## 5- NUOVO ISOLAMENTO SCANDINAVIAN

New Scandinavian insulation - Nouvelle isolation Scandinavien

Tutte le minipiscine sono state dotate di un nuovo tipo di isolamento Scandinavian 3,5 cm in Polyfoam, installato nel telaio di contenimento della spa senza alcuna fessura. Tra il pannello e il pavimento della spa, invece, è l'aria a fungere da isolante: questo risultato è stato ottenuto installando una lastra di ABS a 3 cm dal fondo e creando sacche d'aria isolanti.

All spas have been fitted with a new type of Scandinavian 3.5 cm Polyfoam insulation, installed in the spa's containment frame without any gaps. Between the panel and the spa floor, however, it is the air that acts as insulation: this was achieved by installing an ABS sheet 3 cm from the bottom and creating insulating air pockets.

Tous les spas ont été équipés d'un nouveau type d'isolation Scandinavien en polyfoam de 3,5 cm, installée dans le cadre du spa sans aucun interstice. Entre le panneau et le sol du spa, c'est l'air qui joue le rôle isolant: cela a été réalisé en installant une feuille d'ABS à 3 cm du fond et en créant des poches d'air isolantes.



## 6- COPERTURA TERMICA

Thermo cover - Couverture thermique

Elemento indispensabile per riparare la Spa da agenti atmosferici, animali, foglie. Inoltre aiuta a contenere la dispersione termica.

Essential element to repair the Spa from atmospheric agents, animals, leaves. It also helps to contain heat loss.

Élément indispensable pour réparer le Spa des agents atmosphériques, des animaux, des feuilles. Il aide également à contenir les pertes de chaleur.

T01  
Grafite grey



### COPERTURA TERMICA inclusa nel prezzo

Thermo cover included in the price  
Couverture thermique inclus dans le prix

SQUARE

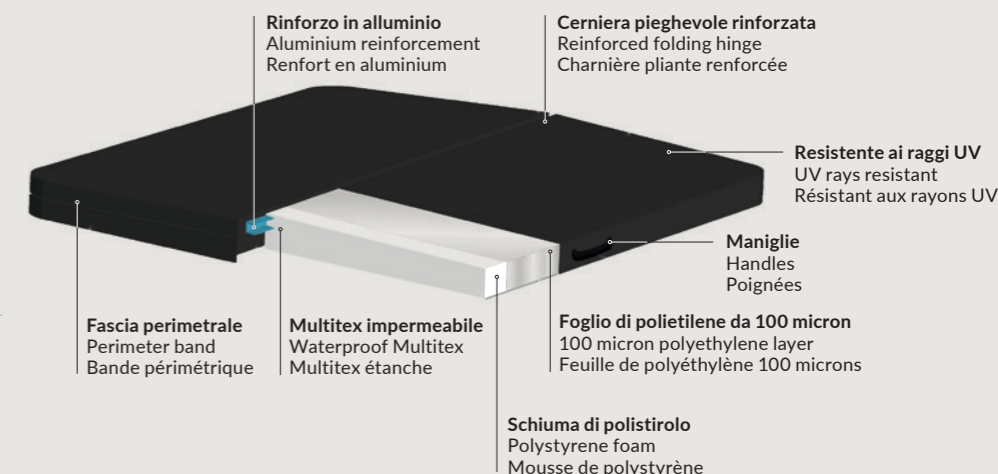
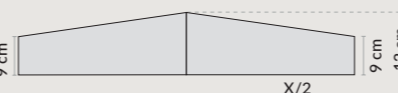



# Caratteristiche tecniche

Technical features - Caractéristiques techniques

## 7- POMPE Pumps - Les pompes



### Pompa W-EC di ricircolo

W-EC circulation pump - Pompe de recirculation W-EC

La pompa W-EC integrata di serie nei modelli Manhattan, Prague, Budapest, Palermo e Lugano, sposta 300 l d'acqua al minuto con un consumo energetico di soli 0,25 Kw.

The W-EC pump, supplied as standard in the Manhattan, Prague, Budapest, Palermo and Lugano, moves 300 liters of water per minute with an energy consumption of only 0.25 Kw.

La pompe W-EC intégrée de série dans les modèles Manhattan, Prague, Budapest, Palermo et Lugano, déplace 300 litres d'eau par minute avec une consommation d'énergie de seulement 0,25 Kw.



Di serie su:  
Standard on - De série sur  
**MANHATTAN / PRAGUE  
BUDAPEST / PALERMO  
LUGANO**



### Pompa di ricircolo

Circulation pump - Pompe de recirculation

Pompa da 1.2 CV (circa 0.9 Kw) di serie per Danube. Ideale per il ricircolo di quantitativi d'acqua importanti.

1.2 HP pump (about 0.9 Kw) as standard for Danube. Ideal for the circulation of large quantities of water.

Pompe de 1,2 HP (environ 0,9 Kw) standard pour Danube. Idéal pour la recirculation de grandes quantités d'eau.

Di serie su:  
Standard on - De série sur  
**DANUBE**



### Pompe idromassaggio

Hydromassage pumps - Pompes d'hydromassage

Le pompe delle Spa sono ottimizzate per offrire la massima potenza ed efficienza in base al numero, alla dimensione e alla funzione dei getti.

Spa pumps are optimized to offer maximum power and efficiency based on the number, size and function of the jets.

Les pompes des minipiscines sont optimisées pour offrir une puissance et une efficacité maximales en fonction du nombre, de la taille et de la fonction des jets.

### W-Flow System

Il sistema W-Flow tramite 3 pompe idromassaggio da 2200W ciascuna (totale 6.6 Kw), crea un flusso d'acqua ideale per il nuoto controcorrente, adatto per garantire un corretto allenamento.

The W-Flow system, through 3 hydro massage pumps of 2200W each (total 6.6 Kw), creates the ideal water flow for counter-current swimming, suitable to ensure a proper training.

Le système W-Flow à travers 3 pompes d'hydromassage de 2200W chacune (total 6,6 Kw), crée un débit d'eau idéal pour la nage à contre-courant, adapte à garantir un entraînement correct.



Di serie su:  
Standard on - De série sur  
**DANUBE**

## 8- SISTEMI DI DISINFEZIONE DELL'ACQUA Water disinfection systems - Systèmes de désinfection de l'eau



### Filtri a cartuccia

Cartridge filters - Filtres à cartouche

Tutte le spa usano un sistema di filtraggio e igienizzazione in più fasi che garantisce un'acqua cristallina.

All spas use a multi-stage filtration and sanitation system that ensures crystal clear water.

Tous les spas utilisent un système de filtration et d'assainissement en plusieurs étapes qui garantit une eau claire et pure.

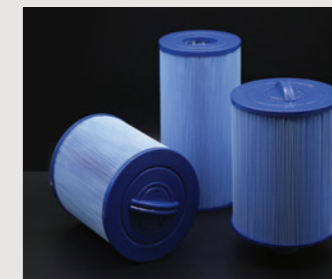

### OZMIX™ SYSTEM

Tutte le spa sono dotate di un innovativo sistema di sanificazione dell'acqua chiamato OZMIX™. Il sistema OZMIX™ è significativamente più efficiente rispetto agli altri sistemi di purificazione dell'acqua delle vasche idromassaggio utilizzati finora grazie all'aggiunta di cloro e alla giusta quantità di pH. L'obiettivo è offrire la migliore modalità di disinfezione possibile e ridurre la quantità di prodotti chimici attualmente in uso.

Godetevi una spa più pulita e sana con il sistema Ozmix™!

The OZMIX™ system is significantly more efficient than the other hot tub water purification and disinfection systems used so far, because of the addition of chlorine and the right amount of pH. The goal is to offer the best possible disinfection mode and reduce the amount of chemicals which are currently in use. Enjoy a cleaner and healthier spa with Ozmix™ system!

Tous les spas sont équipés d'un système innovant de désinfection de l'eau appelé OZMIX™. Le système OZMIX™ est nettement plus efficace que les autres systèmes de purification de l'eau des spas utilisés jusqu'à présent, grâce à l'ajout de chlore et à la bonne quantité de pH. L'objectif est d'offrir le meilleur mode de désinfection possible et de réduire la quantité de produits chimiques actuellement utilisés.

Profitez d'un spa plus propre et plus sain avec le système Ozmix™!

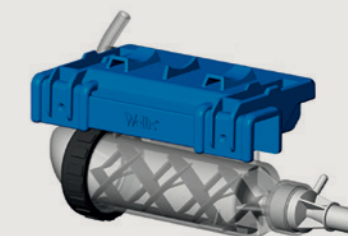

Di serie su:  
Standard on - De série sur  
**MARS / PLUTO  
MANHATTAN / PRAGUE  
BUDAPEST / PALERMO  
LUGANO / DANUBE**

# Caratteristiche tecniche

Technical features - Caractéristiques techniques

## 9- SISTEMA PLUG & PLAY

Plug & Play system - Systeme Plug & Play



### Plug & Play

Con il sistema Plug & Play la spa è facile da installare, pronta all'uso e sicura. Già dotata di cavo e spina con interruttore di sicurezza magneto termico differenziale, la minipiscina idromassaggio si collega direttamente alla presa elettrica di casa. Per rilassarsi nella massima tranquillità.

With the Plug & Play system, the spa is easy to install, ready to use and safe. Already equipped with a cable and a plug with a differential thermal magnetic safety switch, the hydromassage hot tub connects directly to the electrical outlet of the house. To relax in complete tranquility.

Avec le système Plug & Play, la minipiscine est facile à installer, prêt à l'emploi et sûr. Déjà équipé d'un câble et d'une fiche avec un interrupteur de sécurité magnéto-thermique différentiel, la minipiscine se connecte directement à la prise électrique de la maison. Pour se détendre en toute tranquillité.

### Caratteristiche:

Features - Caractéristiques

- Per l'uso esterno: IP54
- Interruttore di spegnimento bipolare
- Tensione nominale: 230V
- Corrente nominale: 16A
- Corrente differenziale nominale: 30 mA
- Spina monofase per il collegamento elettrico
- Lunghezza cavo 4mt
- For outdoor use: IP54
- Two pole switch-off
- Rated voltage: 230V
- Rated current: 16A
- Nominal differential current: 30 mA
- Single-phase plug for electrical connection
- Cable length 4mt

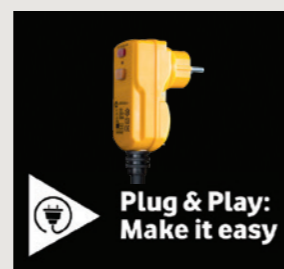

Solo per:  
Only for - Juste pour  
MARS / PLUTO

- Pour une utilisation extérieure: IP54
- Interrupteur bipolaire
- Tension nominale: 230 V
- Courant nominal: 16 A
- Courant différentiel nominal: 30 mA
- Fiche monophasée pour connexion électrique
- Longueur de câble 4mt

## 10- PANNELLI DI CONTROLLO

Control panels - Panneaux de commande



### EASY4

Il pannello Easy4 è compatto, con un ampio schermo LCD.

The Easy4 panel is compact, with a large LCD screen.

L'Easy4 est compact, avec un large écran LCD.



### EASY7

Il pannello Easy7 offre tutte le funzioni di cui avete bisogno in un'unica tastiera. Compatto, con un ampio schermo LCD.

The Easy7 panel offers all the functions you need in a single keyboard Compact, with a large LCD screen.

L'Easy7 comprend toutes les caractéristiques dont vous avez réellement besoin sur un clavier. Compact, avec un large écran LCD.



Di serie su:  
Standard on - De série sur  
MARS / PLUTO



Di serie su:  
Standard on - De série sur  
MANHATTAN / PRAGUE  
BUDAPEST / PALERMO  
LUGANO

## 11- SMART TOUCH PANNELLO

Smart Touch Control - Smart Touch Panneaux



### Smart Touch

- Menù di selezione semplice e veloce per configurare la vostra spa.
- Wifi: collegate il vostro sistema a internet tramite la connessione WiFi per gestire le impostazioni della spa anche lontano da casa. (Disponibile per iPhone e Android)
- Sanificazione dell'acqua: una schermata dedicata vi aiuterà a configurare la filtrazione ideale e le impostazioni di riscaldamento.
- Luminoso schermo LCD: consente di impostare facilmente la temperatura, le modalità invernali e altre funzioni.
- Quick and easy selection menu to set up your spa.
- Wifi: connect your system to the Internet with Wifi connection to be able to manage spa settings even when away from home. (Available for iPhone and Android)
- Water sanitization: a dedicated screen will help you to configure the ideal filtration and heating settings.
- Bright LCD screen: allows an easy setting of the temperature, winter modes and other functions.
- Menu de sélection rapide et facile pour configurer votre spa.
- Wifi: connectez votre système à Internet en WiFi pour gérer les paramètres du spa même lorsque vous n'êtes pas chez vous. (Disponible sur les mobiles iPhone et Android)
- Assainissement de l'eau: la dédiée à l'entretien de l'eau vous aidera à paramétrer les paramètres idéaux pour la filtration et le chauffage.
- Écran lumineux LCD: permet de régler facilement la température, le mode hiver ainsi que d'autres fonctions.



Solo per:  
Only for - Juste pour  
DANUBE

## CONFIGURAZIONE ELETTRONICA

Electronic configuration - Configuration électronique

Le minipiscine utilizzano una tecnologia avanzata: l'installatore o il personale qualificato che esegue il collegamento elettrico può attivare direttamente dal display un limitatore elettronico di consumo, in base alla disponibilità di energia elettrica.

The hot-tubs use advanced technology: the technician or qualified personnel who make the electrical connection can directly activate an electronic consumption limiter from the display, based on the availability of electricity.

Les mini-piscines utilisent une technologie de pointe: l'installateur ou le personnel qualifié qui effectue la connexion électrique peut directement activer un limiteur de consommation électronique à partir de l'écran, en fonction de la disponibilité de l'électricité.

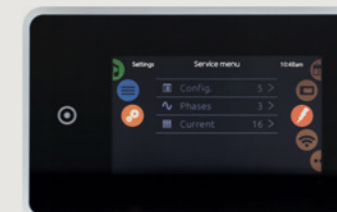

# Caratteristiche tecniche

Technical features - Caractéristiques techniques

## 12- APP SMARTPHONE

Smartphone App - App smartphone



SmartPhone app with wifi

Controllate la vostra spa da remoto grazie all'app SMARTPHONE™! (Disponibile per iPhone e Android). Impostate la temperatura desiderata e altre funzioni direttamente dal vostro telefono.

Control your spa remotely thanks to the SMARTPHONE™ app! (Available for iPhone and Android). Set the desired temperature and other functions directly from your phone.

Contrôlez votre spa à distance avec l'application SMARTPHONE™! (Disponibile sur les mobiles iPhone et Android). Réglez la température souhaitée ainsi que d'autres fonctionnalités à partir de votre téléphone.



App Smartphone

Internet

Router Wi-Fi domestico  
Home Wi-Fi router  
Routeur Wi-Fi domestique

Modulo Wi-Fi  
Wi-Fi module  
Module Wi-Fi

Pronto all'uso per quando arrivi a casa  
Ready to use by the time you arrive home  
Prêt à utiliser quand vous arrivez chez vous



Di serie su:  
Standard on - De série sur  
MANHATTAN / PRAGUE  
BUDAPEST / PALERMO  
LUGANO / DANUBE

## 13- SISTEMI AUDIO

Audio systems - Systèmes audio



MYMUSIC 2.0

Impianto audio con 2 altoparlanti con ricevitore Bluetooth  
Audio system with 2 speakers with Bluetooth receiver  
Système audio avec 2 haut-parleurs avec récepteur bluetooth



AQUASOUL™ PRO 4.1

- Impianto audio con 4 altoparlanti, 1 Subwoofer (120W) con ricevitore Bluetooth
- FM radio
- 2 altoparlanti a scomparsa - 50 W ciascuno
- 2 altoparlanti - 35 W ciascuno

- Audio system with 4 speakers, 1 subwoofer (120W) with Bluetooth receiver
- FM radio
- 2 retractable speakers - 50 W each
- 2 speakers - 35 W each

- Système audio avec 4 haut-parleurs, 1 subwoofer (120W) avec récepteur Bluetooth
- FM radio
- 2 haut-parleurs Pop-Up - 50 W chacun
- 2 haut-parleurs intégrés - 35 W chacun



Di serie su:  
Standard on - De série sur  
DANUBE

## 14- CROMOTERAPIA

Chromotherapy - Chromothérapie



Luci d'atmosfera color therapy

Color therapy ambient lights - Lumières d'ambiance color therapy

La luce regola l'organismo sia dal punto di vista psicologico sia da quello fisiologico: influisce sull'umore, sulla memoria, sull'attenzione, ma anche sulla temperatura corporea, sul battito cardiaco, sul sistema percettivo e sulla psiche (il rosso aumenta i livelli di reattività, il blu predispone alla calma e all'introspezione).

Light regulates the body, psychologically and physiologically: it affects mood, memory, attention, but also on body temperature, heart rate, on the perceptual system and on the psyche (red increases levels of reactivity, blue induces calm and introspection).

L'éclairage régule le corps à la fois d'un point de vue psychologique et physiologique: elle affecte l'humeur, la mémoire, l'attention, mais aussi la température corporelle, la fréquence cardiaque, le système perceptif et la psyché (le rouge augmente la niveau de réactivité, le bleu prédispose au calme et à l'introspection).



Di serie su:  
Standard on - De série sur  
MANHATTAN / PRAGUE  
BUDAPEST / PALERMO / LUGANO



Di serie su tutte le spa  
Standard on all spas - De série sur tous les spas



## LISTINO PREZZI

Price list - Tarif

# Mars

► 213 x 160 x 75 cm



Chromotherapy  
12 LED



Easy4  
control panel



Mymusic 2.0



Thermo cover



**Postazioni**  
Places - Places



x 2  
Postazioni reclinate  
Reclining places - Places inclinables



x 1  
Postazioni di seduta  
Sitting places - Places assises



**Punti di massaggio vedi pag. 06**  
Massage points see page 06 - Points de massage voir page 06

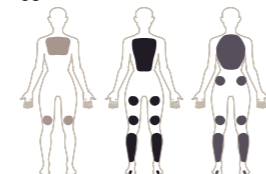

**Colore acrilici**  
Acrylic colours - Couleurs de l'acrylique

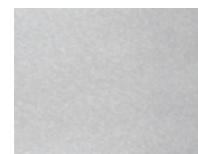

AC2 Sterling Silver



**Colore pannelli**  
Panels colours - Couleurs panneaux



S03 Grey



**Colore copertura termica**  
Thermo cover - Couverture thermique

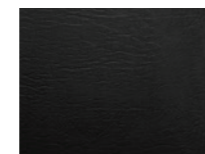

T01 Grafite Grey



Riscaldatore / 2 Kw Con Plug&Play (pag. 16)  
Heater - Chauffage

## Mars

<b>Peso netto (kg) / Volume d'acqua (l)</b> Net weight (kg) / Water volume (l) - Poids net (kg) / Volume d'eau (L)	175 kg / 685 l
<b>Rinforzo</b> Reinforcement - Renforcement	Poli-MAX™
<b>Isolamento</b> Insulation - Isolation	Polyfoam (Scandinavian 3.5 cm)
<b>Scarichi</b> Drains - Siphons	1 sulla parte inferiore 1 pc at the bottom - 1 en bas
<b>Requisiti di potenza</b> Power requirement - Puissance nécessaire	1 x 16A 230V50Hz
<b>Consumo massimo KW</b> Maximum power consumption KW - Consommation électrique maximale KW	2,37 kW
<b>Centralina</b> Control box - Boîtier de contrôle	Gecko (IN.YJ-2)
<b>Numero totale di getti</b> Total number of jets - Nombre total de jets	37 pz. 37 pcs - 37 pcs
<b>Riscaldatore</b> Heater - Chauffage	2 kW
<b>Pompa idromassaggio</b> Hydromassage pump - Pompe hydromassage	1 pz, 2 CV a doppia velocità (0.3 kW - 1.5 kW) 1 pc 2 HP double speed - 1 pc 2 CH double vitesse
<b>Filtro a cartuccia</b> Cartridge filter - Filtre à cartouche	1 filtro in carta / 175 x 152 1 pc paper filter - 1 filtre en papier
<b>Sanificazione dell'acqua</b> Water sanitization - Assainissement de l'eau	Sistema Ozmix™ Ozmix™ system - Système Ozmix™
<b>Poggiatesta</b> Headrests - Appuis-tête	2 pz. 2 pcs - 2 pcs
<b>Copertura termica</b> Thermo cover - Couverture thermique	Di serie Standard - Standard



**Ricambi**  
Spare parts - Pièces détachées



**Filtro a cartuccia 175 x 152 - 1 pz**  
Cartridge filter 175 x 152 - 1 pz  
Filtre à cartouche 175 x 152 - 1 pz



**Copertura per spa MARS**  
Spa cover MARS  
Couverture pour spa MARS



**Accessori**  
Accessories - Accessoires



**Applicazione SmartPhone con wifi**  
SmartPhone Application with wifi  
Application SmartPhone avec wifi

**Vedi altri accessori pag. 40**  
Accessories - Accessoires

# Pluto

► 200 x 200 x 89 cm



Chromotherapy  
16 LED



Easy4  
control panel



Mymusic 2.0



Thermo cover



**Postazioni**  
Places - Places



x 2  
Postazioni reclinate  
Reclining places - Places inclinables



x 3  
Postazioni di seduta  
Sitting places - Places assises



**Punti di massaggio vedi pag. 06**  
Massage points see page 06 - Points de massage voir page 06

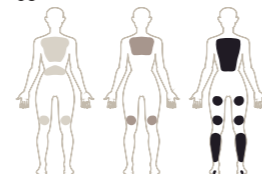

**Colore acrilici**  
Acrylic colours - Couleurs de l'acrylique

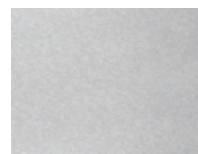

AC2 Sterling Silver



**Colore pannelli**  
Panels colours - Couleurs panneaux



S03 Grey



**Colore copertura termica**  
Thermo cover - Couverture thermique

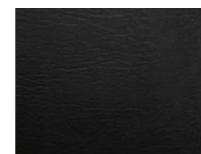

T01 Grafite Grey



Riscaldatore / 2 Kw Con Plug&Play (pag. 16)  
Heater - Chauffage

## Pluto

<b>Peso netto (kg) / Volume d'acqua (l)</b> Net weight (kg) / Water volume (l) - Poids net (kg) / Volume d'eau (L)	247 kg/ 956 l
<b>Rinforzo</b> Reinforcement - Renforcement	Poli-MAX™
<b>Isolamento</b> Insulation - Isolation	Polyfoam (Scandinavian 3.5 cm)
<b>Scarichi</b> Drains - Siphons	1 sulla parte inferiore 1 pc at the bottom - 1 en bas
<b>Requisiti di potenza</b> Power requirement - Puissance nécessaire	1 x 16A 230V50Hz
<b>Consumo massimo KW</b> Maximum power consumption KW - Consommation électrique maximale KW	2,45 kW
<b>Centralina</b> Control box - Boîtier de contrôle	Gecko (IN.YJ-2)
<b>Numero totale di getti</b> Total number of jets - Nombre total de jets	42 pz. 42 pcs - 42 pcs
<b>Riscaldatore</b> Heater - Chauffage	2 kW
<b>Pompa idromassaggio</b> Hydromassage pump - Pompe hydromassage	1 pz, 3 CV a doppia velocità (0.45 kW - 2.2 kW) 1 pc 3 HP double speed - 1 pc 3 CH double vitesse
<b>Filtro a cartuccia</b> Cartridge filter - Filtre à cartouche	2 filtri in carta / 175 x 152 2 pc paper filters - 2 filtres en papier
<b>Sanificazione dell'acqua</b> Water sanitization - Assainissement de l'eau	Sistema Ozmix™ Ozmix™ system - Système Ozmix™
<b>Poggiatesta</b> Headrests - Appuis-tête	3 pz. 3 pcs - 3 pcs
<b>Copertura termica</b> Thermo cover - Couverture thermique	Di serie Standard - Standard



**Ricambi**  
Spare parts - Pièces détachées



**Filtro a cartuccia 175 x 152 - 1 pz**  
Cartridge filter 175 x 152 - 1 pz  
Filtre à cartouche 175 x 152 - 1 pz



**Copertura per spa PLUTO**  
Spa cover PLUTO  
Couverture pour spa PLUTO



**Accessori**  
Accessories - Accessoires



**Applicazione SmartPhone con wifi**  
SmartPhone Application with wifi  
Application SmartPhone avec wifi

**Vedi altri accessori pag. 40**  
Accessories - Accessoires

# Manhattan

▶ 201 x 153 x 85 cm



Central light  
chromotherapy



Easy7  
control panel



SmartPhone App  
with wifi



Mymusic 2.0



Thermo cover



## Postazioni

Places - Places



x 1

Postazioni reclinare  
Reclining places - Places inclinables



x 2

Postazioni di seduta  
Sitting places - Places assises



## Punti di massaggio vedi pag. 06

Massage points see page 06 - Points de massage voir page 06

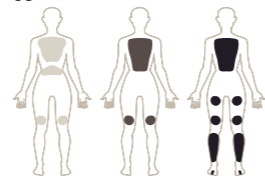

## Colore acrilici

Acrylic colours - Couleurs de l'acrylique

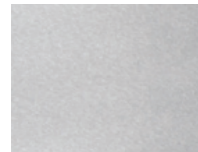

AC2 Sterling Silver



## Colore pannelli

Panels colours - Couleurs panneaux



S03 Grey



## Colore copertura termica

Thermo cover - Couverture thermique

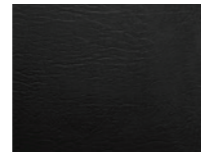

T01 Grafite Grey

## Manhattan

### Peso netto (kg) / Volume d'acqua (l)

Net weight (kg) / Water volume (l) - Poids net (kg) / Volume d'eau (L) 280 kg / 560 l

### Rinforzo

Reinforcement - Renforcement

Poli-MAX™

### Isolamento

Insulation - Isolation

Polyfoam (scandinavian 3.5 cm)

### Requisiti di potenza

Power requirement - Puissance nécessaire

3 x 16A 230V / 50Hz (400V)  
1 x 25A 230V / 50Hz

### Consumo massimo KW

Maximum power consumption KW - Consommation électrique maximale KW

5.45 kW

### Consumo minimo KW

Minimum power consumption KW - Consommation électrique minimale KW

3.25 kW

### Scarichi

Drains - Siphons

1 sulla parte inferiore  
1 pc at the bottom - 1 en bas

### Pompa idromassaggio

Hydromassage pump - Pompe hydromassage

1 x 3 HP - singola velocità (2.2kW)  
1 x 3 HP - single speed - 1 x 3 HP - vitesse unique

### Pompa di ricircolo

Circulation pump - Pompe de circulation

Pompa W-EC (0.25 kW)  
W-EC pump (0.25 kW) - Pompe W-EC (0.25 kW)

### Riscaldatore

Heater - Chauffage

3 kW

### Centralina

Control box - Boîtier de contrôle

Gecko (IN.YE-3) / Easy7

### Sanificazione dell'acqua

Water sanitization - Assainissement de l'eau

Sistema Ozmix™ (ozono + miscelatore)  
Ozmix™ system (ozone + mixer) - Système Ozmix™ (ozone + mixer)

### Filtro a cartuccia

Cartridge filter - Filtre à cartouche

1 x filtro antibatterico / 337 x 124  
1 x antibacterial filter - 1 x filtre antibacterial

### Numero totale di getti

Total number of jets - Nombre total de jets

30 pz.  
30 pcs - 30 pcs

### Poggiatesta

Headrests - Appuis-tête

2 pz.  
2 pcs - 2 pcs

### Copertura termica

Thermo cover - Couverture thermique

Di serie  
Standard - Standard



## Ricambi

Spare parts - Pièces détachées



**Filtro a cartuccia 337 x 124 - 1 pz**  
Cartridge filter 337 x 124 - 1 pz  
Filtre à cartouche 337 x 124 - 1 pz



**Copertura per spa MANHATTAN**  
Spa cover MANHATTAN  
Couverture pour spa MANHATTAN



## Accessori pag. 40

Accessories - Accessoires

# Prague

► 200 x 200 x 90 cm



Central light  
chromotherapy



Easy7  
control panel



SmartPhone App  
with wifi



Mymusic 2.0



Thermo cover



## Postazioni

Places - Places



x 1

Postazioni reclinate  
Reclining places - Places inclinables



x 5

Postazioni di seduta  
Sitting places - Places assises



## Punti di massaggio vedi pag. 06

Massage points see page 06 - Points de massage voir page 06

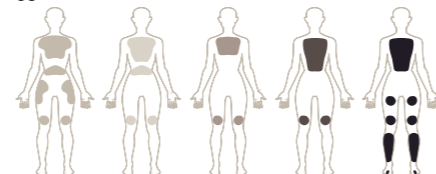

## Colore acrilici

Acrylic colours - Couleurs de l'acrylique

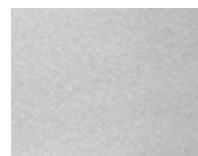

AC2 Sterling Silver



## Colore pannelli

Panels colours - Couleurs panneaux



S03 Grey



## Colore copertura termica

Thermo cover - Couverture thermique

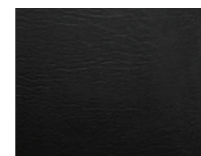

T01 Grafite Grey

## Prague

<b>Peso netto (kg) / Volume d'acqua (l)</b> Net weight (kg) / Water volume (l) - Poids net (kg) / Volume d'eau (L)	226 kg / 1 200 l
<b>Rinforzo</b> Reinforcement - Renforcement	Poli-MAX™
<b>Isolamento</b> Insulation - Isolation	Polyfoam (scandinavian 3.5 cm)
<b>Requisiti di potenza</b> Power requirement - Puissance nécessaire	3 x 16A 230V / 50Hz (400V) 1 x 25A 230V / 50Hz
<b>Consumo massimo KW</b> Maximum power consumption KW - Consommation électrique maximale KW	5.45 kW
<b>Consumo minimo KW</b> Minimum power consumption KW - Consommation électrique minimale KW	3.25 kW
<b>Scarichi</b> Drains - Siphons	1 sulla parte inferiore 1 pc at the bottom - 1 en bas
<b>Pompa idromassaggio</b> Hydromassage pump - Pompe hydromassage	1 x 3 HP - singola velocità (2.2 kW) 1 x 3 HP - single speed - 1 x 3 HP - vitesse unique
<b>Pompa di ricircolo</b> Circulation pump - Pompe de circulation	Pompa W-EC (0.25 kW) W-EC pump (0.25 kW) - Pompe W-EC (0.25 kW)
<b>Riscaldatore</b> Heater - Chauffage	3 kW
<b>Centralina</b> Control box - Boîtier de contrôle	Gecko (IN.YE-3) / Easy7
<b>Sanificazione dell'acqua</b> Water sanitization - Assainissement de l'eau	Sistema Ozmix™ (ozono + miscelatore) Ozmix™ system (ozone + mixer) - Système Ozmix™ (ozone + mixer)
<b>Filtro a cartuccia</b> Cartridge filter - Filtre à cartouche	1 x filtro antibatterico / 337 x 124 1 x antibacterial filter - 1 x filtre antibacterial
<b>Numero totale di getti</b> Total number of jets - Nombre total de jets	50 pz. 50 pcs - 50 pcs
<b>Poggiatesta</b> Headrests - Appuis-tête	3 pz. 3 pcs - 3 pcs
<b>Copertura termica</b> Thermo cover - Couverture thermique	Di serie Standard - Standard



## Ricambi

Spare parts - Pièces détachées



**Filtro a cartuccia 337 x 124 - 1 pz**  
Cartridge filter 337 x 124 - 1 pz  
Filtre à cartouche 337 x 124 - 1 pz



**PRAGUE / BUDAPEST**  
Copertura per spa  
Spa cover - Couverture pour spa



## Accessori pag. 40

Accessories - Accessoires



# Budapest

► 200 x 200 x 89 cm



Central light  
chromotherapy



Easy7  
control panel



SmartPhone App  
with wifi



Mymusic 2.0



Thermo cover



## Postazioni

Places - Places



x 2

Postazioni reclinate  
Reclining places - Places inclinables



x 3

Postazioni di seduta  
Sitting places - Places assises



## Punti di massaggio vedi pag. 06

Massage points see page 06 - Points de massage voir page 06

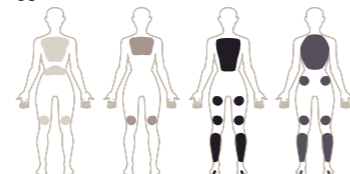

## Colore acrilici

Acrylic colours - Couleurs de l'acrylique

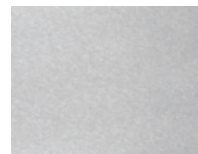

AC2 Sterling Silver



## Colore pannelli

Panels colours - Couleurs panneaux



S03 Grey



## Colore copertura termica

Thermo cover - Couverture thermique

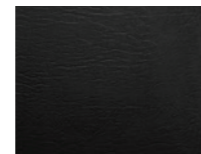

T01 Grafite Grey

## Budapest

<b>Peso netto (kg) / Volume d'acqua (l)</b> Net weight (kg) / Water volume (l) - Poids net (kg) / Volume d'eau (L)	236 kg / 1 100 l
<b>Rinforzo</b> Reinforcement - Renforcement	Poli-MAX™
<b>Isolamento</b> Insulation - Isolation	Polyfoam (scandinavian 3.5 cm)
<b>Requisiti di potenza</b> Power requirement - Puissance nécessaire	3 x 16A 230V / 50Hz (400V) 1 x 25A 230V / 50Hz
<b>Consumo massimo KW</b> Maximum power consumption KW - Consommation électrique maximale KW	5.45 kW
<b>Consumo minimo KW</b> Minimum power consumption KW - Consommation électrique minimale KW	3.25 kW
<b>Scarichi</b> Drains - Siphons	1 sulla parte inferiore 1 pc at the bottom - 1 en bas
<b>Pompa idromassaggio</b> Hydromassage pump - Pompe hydromassage	1 x 3 HP - singola velocità (2.2 kW) 1 x 3 HP - single speed - 1 x 3 HP - vitesse unique
<b>Pompa di ricircolo</b> Circulation pump - Pompe de circulation	Pompa W-EC (0.25 kW) W-EC pump (0.25 kW) - Pompe W-EC (0.25 kW)
<b>Riscaldatore</b> Heater - Chauffage	3 kW
<b>Centralina</b> Control box - Boîtier de contrôle	Gecko (IN.YE-3) / Easy7
<b>Sanificazione dell'acqua</b> Water sanitization - Assainissement de l'eau	Sistema Ozmix™ (ozono + miscelatore) Ozmix™ system (ozone + mixer) - Système Ozmix™ (ozone + mixer)
<b>Filtro a cartuccia</b> Cartridge filter - Filtre à cartouche	1 x filtro antibatterico / 337 x 124 1 x antibacterial filter - 1 x filtre antibacterial
<b>Numero totale di getti</b> Total number of jets - Nombre total de jets	42 pz. 42 pcs - 42 pcs
<b>Poggiatesta</b> Headrests - Appuis-tête	3 pz. 3 pcs - 3 pcs
<b>Copertura termica</b> Thermo cover - Couverture thermique	Di serie Standard - Standard



## Ricambi

Spare parts - Pièces détachées



**Filtro a cartuccia 337 x 124 - 1 pz**  
Cartridge filter 337 x 124 - 1 pz  
Filtre à cartouche 337 x 124 - 1 pz



**BUDAPEST / PRAGUE**  
Copertura per spa  
Spa cover - Couverture pour spa



## Accessori pag. 40

Accessories - Accessoires

# Palermo

► 218 x 218 x 90 cm



Central light  
chromotherapy



Easy7  
control panel



SmartPhone App  
with wifi



Mymusic 2.0



Thermo cover



## Postazioni

Places - Places



x 2

Postazioni reclinate  
Reclining places - Places inclinables



x 3

Postazioni di seduta  
Sitting places - Places assises



## Punti di massaggio vedi pag. 06

Massage points see page 06 - Points de massage voir page 06

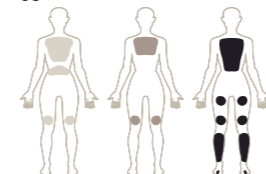

## Colore acrilici

Acrylic colours - Couleurs de l'acrylique

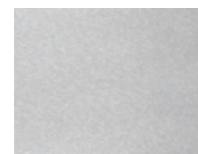

AC2 Sterling Silver



## Colore pannelli

Panels colours - Couleurs panneaux



S03 Grey



## Colore copertura termica

Thermo cover - Couverture thermique

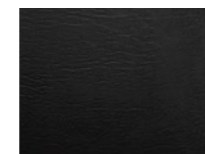

T01 Grafite Grey

## Palermo

<b>Peso netto (kg) / Volume d'acqua (l)</b> Net weight (kg) / Water volume (l) - Poids net (kg) / Volume d'eau (L)	335 kg / 1 175 l
<b>Rinforzo</b> Reinforcement - Renforcement	Poli-MAX™
<b>Isolamento</b> Insulation - Isolation	Polyfoam (scandinavian 3.5 cm)
<b>Requisiti di potenza</b> Power requirement - Puissance nécessaire	3 x 16A 230V / 50Hz (400V) 1 x 32A 230V / 50Hz
<b>Consumo massimo KW</b> Maximum power consumption KW - Consommation électrique maximale KW	7.65 kW
<b>Consumo minimo KW</b> Minimum power consumption KW - Consommation électrique minimale KW	3.25 kW
<b>Scarichi</b> Drains - Siphons	1 sulla parte inferiore 1 pc at the bottom - 1 en bas
<b>Pompe idromassaggio</b> Hydromassage pumps - Pompes hydromassage	2 x 3 HP - singola velocità (2 x 2.2 kW) 2 x 3 HP - single speed - 2 x 3 HP - vitesse unique
<b>Pompa di ricircolo</b> Circulation pump - Pompe de circulation	Pompa W-EC (0.25 kW) W-EC pump (0.25 kW) - Pompe W-EC (0.25 kW)
<b>Riscaldatore</b> Heater - Chauffage	3 kW
<b>Centralina</b> Control box - Boîtier de contrôle	Gecko (IN.YE-3) / Easy7
<b>Sanificazione dell'acqua</b> Water sanitization - Assainissement de l'eau	Sistema Ozmix™ (ozono + miscelatore) Ozmix™ system (ozone + mixer) - Système Ozmix™ (ozone + mixer)
<b>Filtro a cartuccia</b> Cartridge filter - Filtre à cartouche	1 x filtro antibatterico / 337 x 124 1 x antibacterial filter - 1 x filtre antibacterial
<b>Numero totale di getti</b> Total number of jets - Nombre total de jets	42 pz. 42 pcs - 42 pcs
<b>Poggiatesta</b> Headrests - Appuis-tête	3 pz. 3 pcs - 3 pcs
<b>Copertura termica</b> Thermo cover - Couverture thermique	Di serie Standard - Standard



## Ricambi

Spare parts - Pièces détachées



**Filtro a cartuccia 337 x 124 - 1 pz**  
Cartridge filter 337 x 124 - 1 pz  
Filtre à cartouche 337 x 124 - 1 pz



**Copertura per spa PALERMO**  
Spa cover PALERMO  
Couverture pour spa PALERMO



## Accessori pag. 40

Accessories - Accessoires

# Lugano

► 230 x 230 x 94 cm



Central light  
chromotherapy



Easy7  
control panel



SmartPhone App  
with wifi



Mymusic 2.0



Thermo cover



**Postazioni**  
Places - Places



x 1  
Postazioni reclinate  
Reclining places - Places inclinables



x 5  
Postazioni di seduta  
Sitting places - Places assises



**Punti di massaggio vedi pag. 06**  
Massage points see page 06 - Points de massage voir page 06

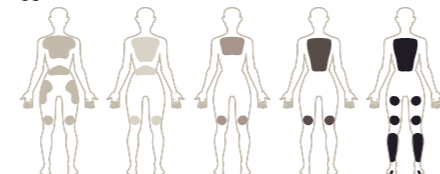

**Colore acrilici**  
Acrylic colours - Couleurs de l'acrylique



AC2 Sterling Silver



**Colore pannelli**  
Panels colours - Couleurs panneaux



S03 Grey



**Colore copertura termica**  
Thermo cover - Couverture thermique

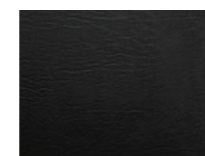

T01 Grafite Grey

## Lugano

<b>Peso netto (kg) / Volume d'acqua (l)</b> Net weight (kg) / Water volume (l) - Poids net (kg) / Volume d'eau (L)	387 kg / 1 400 l
<b>Rinforzo</b> Reinforcement - Renforcement	Poli-MAX™
<b>Isolamento</b> Insulation - Isolation	Polyfoam (scandinavian 3.5 cm)
<b>Requisiti di potenza</b> Power requirement - Puissance nécessaire	3 x 16A 230V / 50Hz (400V) 1 x 32A 230V / 50Hz
<b>Consumo massimo KW</b> Maximum power consumption KW - Consommation électrique maximale KW	7.65 kW
<b>Consumo minimo KW</b> Minimum power consumption KW - Consommation électrique minimale KW	3.25 kW
<b>Scarichi</b> Drains - Siphons	1 sulla parte inferiore 1 pc at the bottom - 1 en bas
<b>Pompe idromassaggio</b> Hydromassage pumps - Pompes hydromassage	2 x 3 HP - singola velocità (2 x 2 kW) 2 x 3 HP - single speed - 2 x 3 HP - vitesse unique
<b>Pompa di ricircolo</b> Circulation pump - Pompe de circulation	Pompa W-EC (0.25 kW) W-EC pump (0.25 kW) - Pompe W-EC (0.25 kW)
<b>Riscaldatore</b> Heater - Chauffage	3 kW
<b>Centralina</b> Control box - Boîtier de contrôle	Gecko (IN.YE-3) / Easy7
<b>Sanificazione dell'acqua</b> Water sanitization - Assainissement de l'eau	Sistema Ozmix™ (ozono + miscelatore) Ozmix™ system (ozone + mixer) - Système Ozmix™ (ozone + mixer)
<b>Filtro a cartuccia</b> Cartridge filter - Filtre à cartouche	1 x filtro in carta / 175 x 152 1 x paper filter - 1 x filtre en papier
<b>Numero totale di getti</b> Total number of jets - Nombre total de jets	52 pz. 52 pcs - 52 pcs
<b>Poggiatesta</b> Headrests - Appuis-tête	3 pz. 3 pcs - 3 pcs
<b>Copertura termica</b> Thermo cover - Couverture thermique	Di serie Standard - Standard



**Ricambi**  
Spare parts - Pièces détachées



**Filtro a cartuccia 175 x152 - 1 pz**  
Cartridge filter 175 x152 - 1 pz  
Filtre à cartouche 175 x152 - 1 pz



**Copertura per spa LUGANO**  
Spa cover LUGANO  
Couverture pour spa LUGANO



**Accessori pag. 40**  
Accessories - Accessoires

# Danube

► 453 × 235 × 147 cm



Chromotherapy  
18 LED



Swimming stick



SmartPhone App  
with wifi



Aquasoul™ Pro 4.1



SmartTouch  
control panel



Circulation pump



Thermo cover



## Pannellatura

Paneling - Panneaux

Al momento dell'ordine specificare se versione con pannellatura completa o semincasso.  
When ordering, specify whether version with full or semi-recessed panels.  
Lors de la commande, précisez s'il s'agit d'une version avec panneaux entiers ou semi-encastés.

### Semincasso

Semi-recessed - Semi-encastée

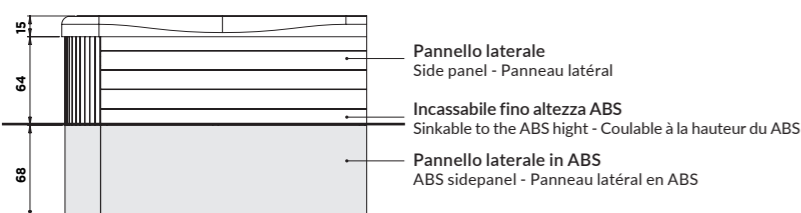

### Freestanding

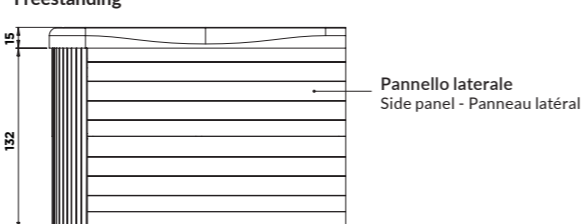

## Postazioni

Places - Places



x 2

Postazioni di seduta  
Sitting places - Places assises



x 1

Postazione per nuoto  
Swimming station - Station de natation



## Colore acrilici

Acrylic colours - Couleurs de l'acrylique

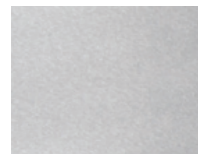

AC2 Sterling Silver



## Colore pannelli

Panels colours - Couleurs panneaux



S03 Grey



## Colore copertura termica

Thermo cover - Couverture thermique

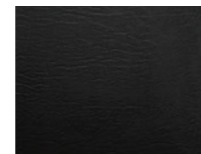

T01 Grafite Grey



## Punti di massaggio vedi pag. 06

Massage points see page 06 - Points de massage voir page 06

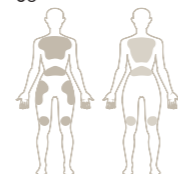

## Danube

<b>Peso netto (kg) / Volume d'acqua (l)</b> Net weight (kg) / Water volume (l) - Poids net (kg) / Volume d'eau (L)	1047 kg/5913 l
<b>Rinforzo</b> Reinforcement - Renforcement	Poli-MAX™
<b>Isolamento</b> Insulation - Isolation	Polyfoam (scandinavian 3.5 cm)
<b>Scarichi</b> Drains - Siphons	1 sulla parte inferiore 1 pc at the bottom - 1 en bas
<b>Requisiti di potenza</b> Power requirement - Puissance nécessaire	3 x 16A 230V50Hz / 1 x 25A 230V50Hz
<b>Consumo massimo KW</b> Maximum power consumption KW - Consommation électrique maximale KW	12,9 kW
<b>Consumo minimo KW</b> Minimum power consumption KW - Consommation électrique minimale KW	4,1 kW
<b>Centralina / Pannello di controllo</b> Control box / Control panel - Boîtier de contrôle / Panneau de contrôle	Gecko (IN.YE-8) / Smart Touch
<b>Numero totale di getti</b> Total number of jets - Nombre total de jets	24 pz. 24 pcs - 24 pcs
<b>Getti a fontana laminari</b> Laminar fountain jets - Jets de fontaine laminaires	2 x 3 pz - 2 x 3 pcs - 2 x 3 pcs
<b>Riscaldatore</b> Heater - Chauffage	3 kW
<b>Pompa idromassaggio</b> Hydromassage pump - Pompe hydromassage	1 pz, 3 CV a singola velocità (2.2 kW) 1 pc 3 HP single speed - 1 pc 3 CH vitesse unique
<b>Pompe (spa per nuoto)</b> Pumps (swim spa) - Pompes (spa de nage)	3 pz, 3 CV a singola velocità (3 x 2.2 kW) 3 pcs 3 HP single speed - 3 pcs 3 CH vitesse unique
<b>Pompa di ricircolo</b> Circulation pump - Pompe de circulation	Pompa da 1,2 CV (0.9 kW) 1,2 HP pump - Pompe 1,2 CH
<b>Filtro a cartuccia</b> Cartridge filter - Filtre à cartouche	2 x filtri antibatterici / 337 x 124 2 x antibacterial filters - 2 x filtres antibacterial
<b>Sanificazione dell'acqua</b> Water sanitization - Assainissement de l'eau	Sistema Ozmix™ (ozono + miscelatore) Ozmix™ system (ozone + mixer) - Système Ozmix™ (ozone + mixer)
<b>Poggiatesta</b> Headrests - Appuis-tête	2 pz. 2 pcs - 2 pcs
<b>Copertura termica</b> Thermo cover - Couverture thermique	Di serie Standard - Standard
<b>Asticella per nuoto</b> Swimming stick - Bâton de natation	Di serie Standard - Standard
<b>Predisposizione per scambiatore di calore</b> Heat exchanger preparation - Préparation pour échangeur thermique	Di serie Standard - Standard

## Optional



**Attrezzatura per vogatore**  
Rowing Equipment  
Équipement d'aviron



**Allenamento con estensore**  
Expander Training  
Extenseur d'entraînement



**Scaletta 147 x 165 x L 93,5 cm**  
Stepladder  
Échelle



## Ricambi

Spare parts - Pièces détachées



**Filtro a cartuccia 337 x 124 - 1 pz**  
Cartridge filter 337 x 124 - 1 pz  
Filtre à cartouche 337 x 124 - 1 pz



**Copertura per spa DANUBE**  
Spa cover DANUBE  
Couverture pour spa DANUBE



## Accessori pag. 40

Accessories - Accessoires

►  
Colonna Outdoor  
collection



## Accessori

Accessories - Accessoires

### Colonna Outdoor

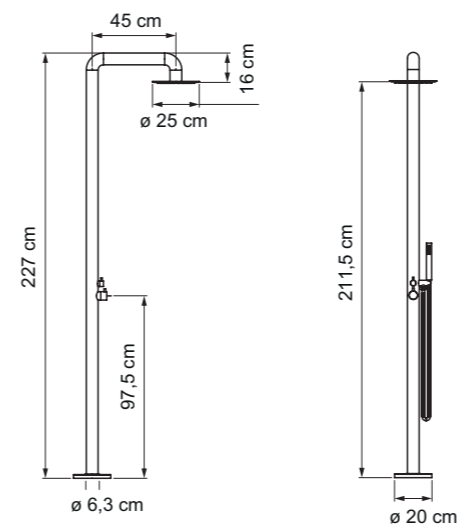

- set colonna doccia uso interno ed esterno in Aisi 316L spazzolato
- miscelatore
- deviatore
- soffione Ø 25 cm
- doccetta tonda 1 getto
- flessibile con sistema antitorsione L 150 cm

- shower column set for indoor and outdoor use in brushed Aisi 316L
- mixer
- diverter
- shower head Ø 25 cm
- round hand shower 1 jet
- flexible with anti-torsion system L 150 cm

- set colonne de douche pour utilisation intérieure et extérieure en Aisi 316L brossé
- mitigeur
- inverseur
- pomme de douche Ø 25 cm
- douchette ronde 1 jet
- flexible avec système anti-torsion L 150 cm



# Accessori

Accessories - Accessoires



## Impugnatura Spa Grip (No Danube)

Spa Grip handle - Poignée pour spa

L'impugnatura antiscivolo può essere fissata al pannello laterale della spa per consentire un accesso sicuro.

The non-slip handle can be fixed to the side panel of the spa for safe access.

La poignée antidérapante peut être fixée sur le panneau latéral du spa pour un accès sécurisé.



## Corrimano a pavimento (No Danube)

Floor-mounted handrail - Main courante au sol

Il corrimano in acciaio inossidabile può essere fissato a terra separatamente dalla spa.

The stainless steel handrail can be fixed to the ground separately from the spa.

La main courante en acier inoxydable peut être fixée au sol séparément du spa.



## Barra porta asciugamani

Towel bar - Porte-serviettes

Un accessorio pratico per tenere gli asciugamani a portata di mano. Può essere ripiegata in caso di inutilizzo.

A practical accessory for keeping towels at hand. Can be folded when not in use.

Un accessoire pratique pour garder les serviettes à proximité. Peut être plié lorsqu'il n'est pas utilisé.



## Vassoio girevole

Revolving tray - Plateau pivotant

Il vassoio girevole è dotato di un supporto in acciaio inossidabile che può essere montato sul pannello laterale della spa.

The swivel tray is equipped with a stainless steel stand that can be mounted on the side panel of the spa.

Le plateau tournant comporte un support en acier inoxydable qui peut être monté sur le tablier latéral du spa.



## Kit di pulizia manuale Spa Wand

Spa Wand manual cleaning kit- Kit de nettoyage manuel Spa Wand

Grazie al kit di pulizia Spa Wand è possibile accedere anche alle aree più difficili, senza necessità di rimuovere l'acqua dalla minipiscina.

Thanks to the Spa Wand cleaning kit, even the most difficult areas can be reached with no need to remove water from the spa.

Avec le kit de nettoyage Spa Wand, il est possible d'accéder aux zones les plus difficiles d'accès sans avoir besoin de retirer l'eau du spa.



## Gradino in legno per spa 60 x 60 x H 40 cm (Dark Grey)

Wooden spa step - Marche du spa en bois

Gradini per accesso alla spa.

Steps to offer access to the spa.

Des marches pour un accès au spa.



## Sollevatore per copertura

Easy cover lifter - Houss pour spa

Grazie al sollevatore è possibile rimuovere facilmente la copertura termica.

Si adatta a tutte le dimensioni delle spa ed è dotato di impugnatura antiscivolo.

· peso: 4,5 kg / lunghezza: 175-235 cm / larghezza: 190-250 cm / altezza: 80-105 cm / spazio dietro la spa: 40 cm circa.

With the use of the Easy-Lifter cover lifter, it is possible to easily remove the thermo cover.

It fits all spa sizes and has non-slip handle.

· weight: 4.5 kg / length: 175-235 cm / width: 190-250 cm / height: 80-105 cm / space behind the spa: about 40 cm.

Avec l'utilisation du lève-couverture Easy-Lifter, une personne peut facilement retirer la couverture thermique.

Il s'adapte à toutes les tailles de spa et dispose d'une poignée antidérapante.

· poids: 4,5 kg / longueur: 175-235 cm / largeur: 190-250 cm / hauteur: 80-105 cm / espace derrière la minipiscine: environ 40 cm

## Danube prevede l'acquisto di 2 cover lifter.

Danube expected the purchase of 2 face-down covers.

Danube attendu l'achat de 2 couvertures face cachée.

## Kit My Spa

Per il trattamento dell'acqua eco compatibile che può essere usato nella vostra spa o vasca idromassaggio.  
Kit my spa vi aiuterà a mantenere pulita l'acqua nella vostra spa in modo sicuro, semplice ed efficace.

For environmentally compatible water treatment for use in your spa or whirlpool tub.

Hafro My Spa kits help you keep your spa water clean safely, easily and effectively.

Pour le traitement de l'eau éco compatible qui peut être utilisé dans votre spa ou dans la baignoire d'hydromassage.

Le kit my spa Hafro vous aidera à conserver la propreté de l'eau dans votre spa de manière sécurisée, simple et efficace.



- (ossigeno + antialga + antischiuma + PH + tester + Filter clean)
- (oxygen + antialgae + antifoam + pH + tester + Filter cleaner)
- (oxygène + antialgues + antimousse + pH + testeur + nettoyant à filtre)

### Prodotto singolo My Spa

Single product - Produit simple

1,2 kg Ossigeno in pastiglie Oxygen tablets Oxygène en pastilles	1,5 kg Riduttore PH granulare Granular pH reducer Réducteur de pH granulaire
---	---

1L Antialga concentrato Concentrated antialgae Antialgues concentré	Tester PH pH Testeur pH
--	-------------------------------

500 ml Antischiuma concentrato Concentrated antifoam Antimousse concentré	1L Filter clean flacone Bottle of filter cleaner Flacon nettoyant à filtre
--	---

## Optional Danube

### Set allenamento swim

Training swim set - Ensemble d'entraînement

Il vogatore e l'estensore devono essere specificati al momento dell'ordine della spa Danube.

The rowing equipment and expander must be specified when ordering the Danube spa.

L'équipement d'aviron et l'extenseur doivent être spécifiés lors de la commande du spa Danube.

### Estensore

Expander - Extenseur



### Vogatore

Rowing - Rameur



### Scaletta

Stepladder - Échelle



147 x 165 x L 93,5 cm

## Condizioni generali di vendita

**1. ORDINI:**  
Qualsiasi ordine è impegnativo per il committente; lo diventa per Gruppo Geromin srl solo a seguito di specifica conferma scritta.

**2. ANNULLAMENTO ORDINI:**  
L'annullamento di un ordine implica l'accettazione scritta da parte di Gruppo Geromin srl.  
Gruppo Geromin srl si riserva la facoltà di addebitare al committente tutti gli oneri conseguenti.

**3. TEMPI DI CONSEGNA:**  
I tempi di consegna devono esser considerati puramente indicativi; in caso di ritardo non è riconosciuto alcun indennizzo. La consegna dell'ordine si intende evasa all'atto della presa in carico del prodotto, presso il magazzino Gruppo Geromin srl, da parte del vettore incaricato del trasporto.

**4. PAGAMENTI:**  
Le condizioni di pagamento, se non diversamente indicate in fattura, sono le seguenti:  
· vendite nazionali: 30 gg df, in presenza di una linea di credito accordata; diversamente, pagamento anticipato all'atto della consegna  
· vendite export: lettera di credito irrevocabile confermata da primario istituto di credito italiano.  
I prodotti forniti rimangono di proprietà di Gruppo Geromin srl fino all'avvenuto completo pagamento, in conformità agli artt. 1523 e seguenti del Codice Civile.

**5. DANNI DA TRASPORTO:**  
Il cliente che riceve un prodotto danneggiato durante il trasporto deve firmare, con riserva, la bolla di consegna e comunicare ad Gruppo Geromin srl, entro il termine di 8 giorni, a mezzo lettera mail o lettera raccomandata, il danno rilevato.

**6. RESI:**  
I resi devono essere espressamente autorizzati da Gruppo Geromin srl. In ogni caso restano a carico del committente gli oneri relativi al trasporto, nonché i costo amministrativi quantificati nella cifra minima del 25% del valore di fatturazione. Non si accettano resi riguardanti prodotti realizzati su specifica richiesta.

**7. GARANZIA:**  
I prodotti Gruppo Geromin srl hanno una garanzia di 24 mesi a decorrere dalla data di consegna.

**8. PREZZI:**  
I prezzi del presente listino sono Iva esclusa e per merce resa franco fabbrica. L'installazione dei prodotti è sempre esclusa e deve avvenire a cura dell'utilizzatore finale. Gruppo Geromin srl si riserva la facoltà di variare i prezzi di listino senza obbligo di preavviso.

**9. RESPONSABILITÀ PER EVENTUALI DANNI:**  
In presenza di eventuali danni causati da difettosità di prodotto, Gruppo Geromin srl se ne farà carico nella misura prevista dalla legislazione vigente.

**10. FORO COMPETENTE:**  
Per qualsiasi controversia è esclusivamente competente il foro di Venezia.

**\_REV 00** Le foto sono puramente dimostrative. Riferirsi alle schede tecniche per dettagli tecnici. Gruppo Geromin srl si riserva il diritto di apportare modifiche al prodotto in qualsiasi momento senza darne alcun preavviso.

## General terms and conditions of sale

**1. ORDERS:**  
All orders are binding for the client. Orders become binding for Gruppo Geromin srl only after written confirmation.

**2. ORDER CANCELLATION:**  
The cancellation of an order requires the written approval by Gruppo Geromin srl. Gruppo Geromin srl is entitled to charge all resulting expense to the client.

**3. DELIVERY TIMES:**  
Delivery times are purely indicative. No compensation will be due in the event of delays. The delivery of an order is processed as soon as the carrier picks up the products from the Gruppo Geromin srl warehouse.

**4. PAYMENTS:**  
Unless otherwise stated in the invoice, the payment terms are the following:  
· national sales: 30 days invoice date in the presence of an approved credit line; otherwise, payment upon delivery  
· International sales: irrevocable letter of credit confirmed by a major Italian bank.  
The products will remain property of Gruppo Geromin srl until the payment is made, in compliance with articles 1523 et seq. of the Italian Civil Code.

**5. DAMAGE DURING TRANSPORT:**  
Customers who receive a product that was damaged during transport must sign the delivery notesubject to verification and report the damage to Gruppo Geromin srl via email or registered letter within 8 days.

**6. RETURNS:**  
Returns must be expressly authorised by Gruppo Geromin srl. In any instance, all resulting transport and administration costs will be charged to the client, with a minimum charge equal to 25% of the invoice value. Tailor-made products made upon specific request cannot be returned.

**7. WARRANTY:**  
All Gruppo Geromin srl products are covered by a 24-month warranty from the delivery date.

**8. PRICES:**  
The prices in this list are VAT excluded and ex works. Product installation is always excluded and must be carried out by the end user. Gruppo Geromin srl reserves the right to change the prices without prior notice.

**9. LIABILITY FOR DAMAGE:**  
In the event of damage caused by a defective product, Gruppo Geromin srl will be held liablein compliance with the laws in force.

**10. COURT OF JURISDICTION:**  
Any dispute will be settled by the Court of Venice.

**\_REV 00** Images are purely illustrative. Refer to the technical data sheets for technical details. Gruppo Geromin srl reserves the right to modify its products at any time without prior notice.

## Conditions générales de vente

**1. COMMANDES :**  
Toute commande passée par le client est ferme et définitive ; elle le devient pour Gruppo Geromin srl uniquement après confirmation écrite.

**2. ANNULATION DES COMMANDES :**  
L'annulation d'une commande implique l'approbation écrite de la part de Gruppo Geromin srl. Gruppo Geromin srl se réservent le droit de facturer au client le remboursement des frais inhérents.

**3. DÉLAIS DE LIVRAISON :**  
Les délais de livraison doivent être considérés à titre purement indicatif ; en cas de retard, aucune indemnisation ne sera accordée.  
La livraison de la commande sera considérée évasée dès la prise en charge de la marchandise auprès de l'entrepôt Gruppo Geromin srl, de la part du transporteur chargé du transport.

**4. PAIEMENTS :**  
Les conditions de paiement, sauf indication contraire mentionnée sur la facture, sont les suivantes:  
· ventes nationales : 30 jours à partir de la date d'émission de la facture, en présence d'une ligne de crédit accordée ; autrement, paiement anticipé au moment de la livraison.  
· ventes à l'étranger : lettre de crédit irrévocable confirmée par une banque italienne de première importance.  
Les produits livrés restent de la propriété de la société Gruppo Geromin srl jusqu'à la fin du paiement du prix, conformément aux articles 1523 et suivants du Code civil.

**5. DOMMAGES DE TRANSPORT :**  
Le client qui reçoit un produit endommagé durant le transport, doit signer le bon de livraison sous réserve et communiquer, à Gruppo Geromin srl, le dommage identifié dans les 8 jours qui suivent la date de livraison, par lettre mail ou lettre recommandée.

**6. RETOURS :**  
Les retours de marchandise doivent être exclusivement autorisés par Gruppo Geromin srl, Dans tous les cas, les frais de transport et les éventuelles charges administratives restent toutefois à la charge du client, quantifiés par le montant minimum de 25% de la valeur de la facture. Les retours concernant les produits réalisés sur demande spécifique ne sont pas acceptés.

**7. GARANTIE :**  
Les produits Gruppo Geromin srl ont une garantie de 24 mois à partir de la date de livraison.

**8. PRIX :**  
Les prix de cette liste sont hors TVA et pour des marchandises départ usine. L'installation des produits est toujours exclue et doit être effectuée par l'utilisateur final. Gruppo Geromin srl se réserve le droit de modifier les prix de la liste sans obligation de préavis.

**9. RESPONSABILITÉS POUR ÉVENTUELS DOMMAGES :**  
En présence d'éventuels dommages causés par des défauts de fabrication, Gruppo Geromin srl est retenue responsable selon les termes prévus par la réglementation en vigueur.

**10. TRIBUNAL COMPÉTENT :**  
Le tribunal défini comme compétent pour régler tout litige est celui de Venise.

**\_REV 00** Les photos sont à titre purement indicatif. Se référer aux fiches techniques pour les détails techniques. Gruppo Geromin srl se réserve le droit de modifier le produit à tout moment et sans préavis.







[gruppogeromin.com](http://gruppogeromin.com)

Design & Coordination **Gruppo Geromin** | Art direction Graphic Design **Lokomotiv** | Colour separation **Luce** |  
Print **AGCM** | July 2023



GRUPPO GEROMIN  
VENEZIA 1945

HAFRO | SAUNAVITA | GEROMIN

GRUPPO GEROMIN Srl  
Via 1° Maggio, 5 - 30029 San Stino di Livenza VE-I  
TEL +39 0421 312 249 - 312 250  
[info@gruppogeromin.com](mailto:info@gruppogeromin.com) [www.gruppogeromin.com](http://www.gruppogeromin.com)