

Tex

by Raw Edges



MU
TIN
A

Tex

by Raw Edges

L'idea di una collezione ceramica ricca e multicolore ispirata alle texture tessili è stato il punto di partenza del progetto sviluppato dallo studio Raw Edges di Londra per Mutina. "Riuscire a creare una texture tangibile è la vera sfida quando si disegnano piastrelle in ceramica", affermano i due giovani designer. "A sorpresa sono state proprio le texture tessili a condurci alla definizione della nuova collezione Tex. La forma della piastrella è un ingrandimento semplificato della lavorazione a maglia di base: osservando attentamente un tessuto lavorato a maglia, si può vedere una ripetizione di cuciture, allineate in file simmetriche una di fianco all'altra. I rombi possono essere disposti in tre pattern principali, ognuno dei quali ha un impatto differente. La collezione ha 8 differenti colori, ciascuno declinato in tre tonalità, un mix ispirato proprio al design tessile, dove un solo tipo di tessuto può essere costituito dalle diverse sfumature di un filato. Per amplificare l'effetto sorpresa e stimolare la creatività e personalizzazione, le tre tonalità saranno inserite in modo casuale nel packaging di Tex così che, durante la posa delle piastrelle, si potranno ottenere composizioni inaspettate. Allo stesso modo, sono previsti i Runner, installazioni su rete con pattern predefiniti, simili a mosaici. I Runner permetteranno di collocare gli elementi grafici in posizioni particolari sia a rivestimento che a pavimento (ad esempio a cornice, come elemento centrale o pattern lineare). La produzione di Tex esalta la varietà delle texture, l'autenticità dei colori e le qualità tattili dello smalto. Inoltre la verniciatura colorata e naturale applicata alla ceramica crea una lucentezza irregolare in alcuni luoghi e più satura in altri".

A rich multi-colored ceramic tile collection inspired by textiles textures was the starting point of the new project designed for Mutina by Raw Edges studio in London. "Creating a tangible texture is one of the challenges when designing ceramics tiles", the two young designers state". To our surprise, it were the textures taken from textiles, which have led us to define the new collection Tex. The shape of the tile is a simplified enlargement of the basic knitted stitch: when looking carefully into a knitted textile, a repetition of stitches can be seen aligned in symmetric rows next to each other. This rhombus can be arranged in three main fashions, each of which has a different impact. The collection has eight different colors, each of which contains a group of three shades. This triple shade mixture was inspired as well by textile design, re-creating the feel of the different tones of the yarn. To enhance the surprise effect and to increase the creativity and personalization, the three shades will be placed randomly in the packages; by this, when installing Tex, arbitrary arrangements could be achieved. On the other hand, in addition to the single tiles installation, premade patterns named Runner, will be arranged on a mesh similarly to mosaics settings. These meshes will allow locating graphic elements in particular places on the wall or on the floor (for instance, as a frame to the room, a central element or a linear pattern). The production of Tex enhances a large multiplicity of textures, the variety of colors and the tactile qualities of the glaze. In addition, the colorful and natural glaze applied on ceramic creates an irregular effect in certain places, while a more saturated one in others".



Se ci guardiamo intorno, ci accorgiamo che quasi ogni oggetto ha una particolare finitura, sia esso un materiale naturale, sia esso handmade. Più che creare noi ex novo altre texture, abbiamo ricercato l'effetto impronta e costruito un nostro book tattile di riferimento ricavando calchi in plastilina delle superfici di oggetti e materiali per noi interessanti.

Looking around us, almost every object has its own particular texture, whether it is a natural or a handmade material. Rather than designing new textures by ourselves, we have reached a print effect and created our reference tactile library by placing plasticine on objects and materials we thought were interesting.

Yael Mer & Shay Alkalay

Tex collection



unico formato 11,5x20 cm
only size 11,5x20 cm



texture tattili
tactile textures



5 texture miscelate random
5 textures mixed randomly



8 colori
8 colours



3 tonalità per ogni colore
3 shades four each colour



1 elemento battiscopa
1 skirting element

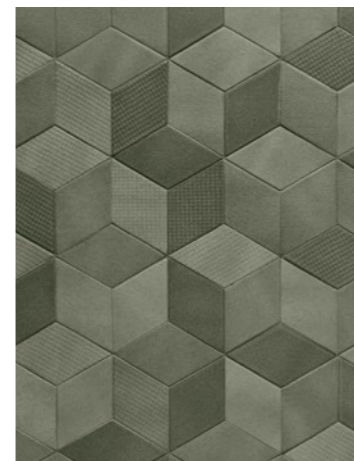

3 schemi di posa differenti
3 main laying patterns

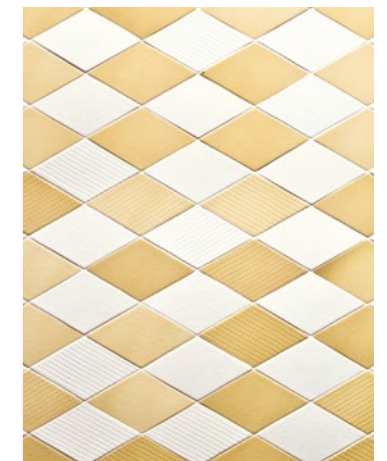



White, Cream, Yellow

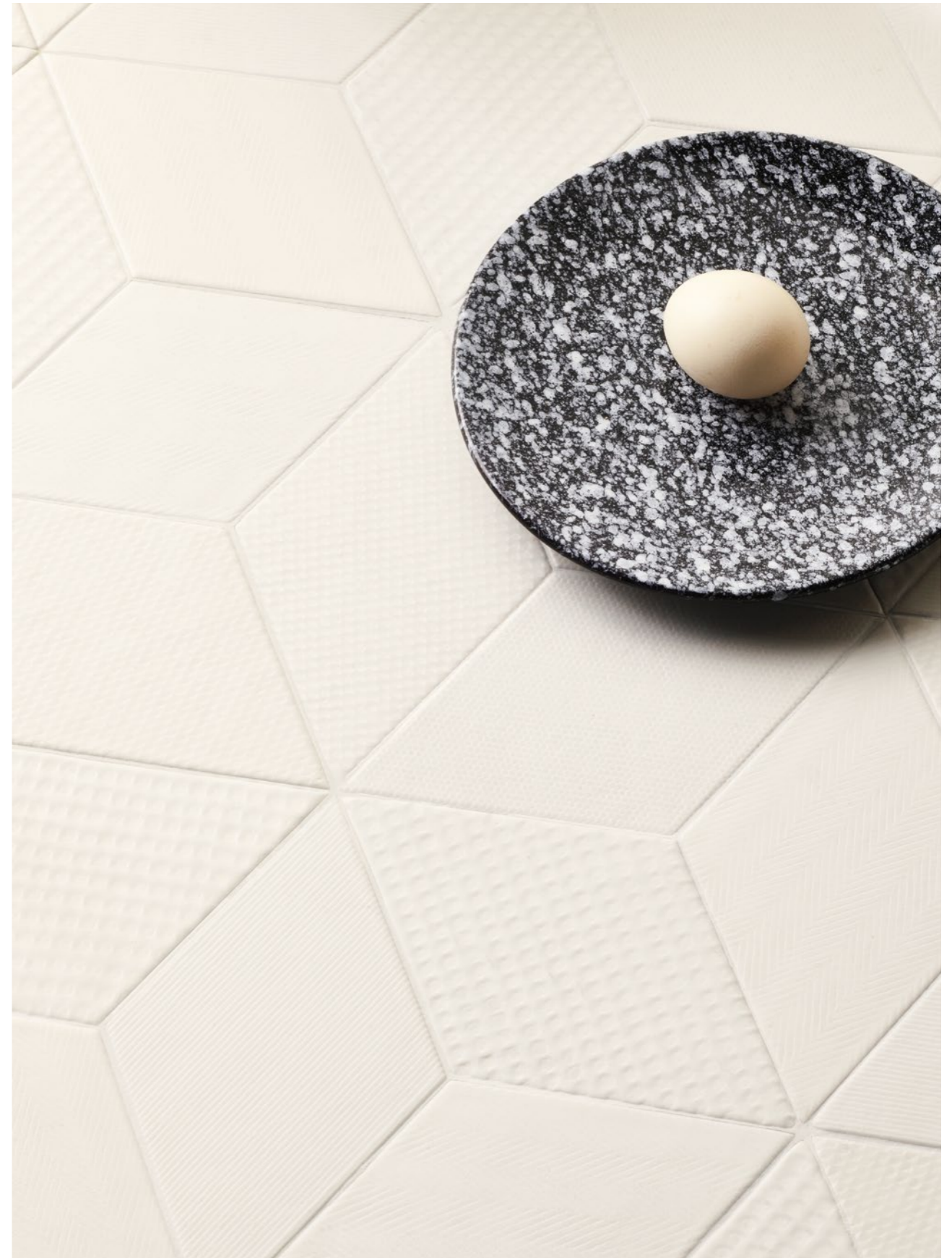







Cream, Blue, Cream battiscopa





Wall: White, Olive, Cream
Floor: White

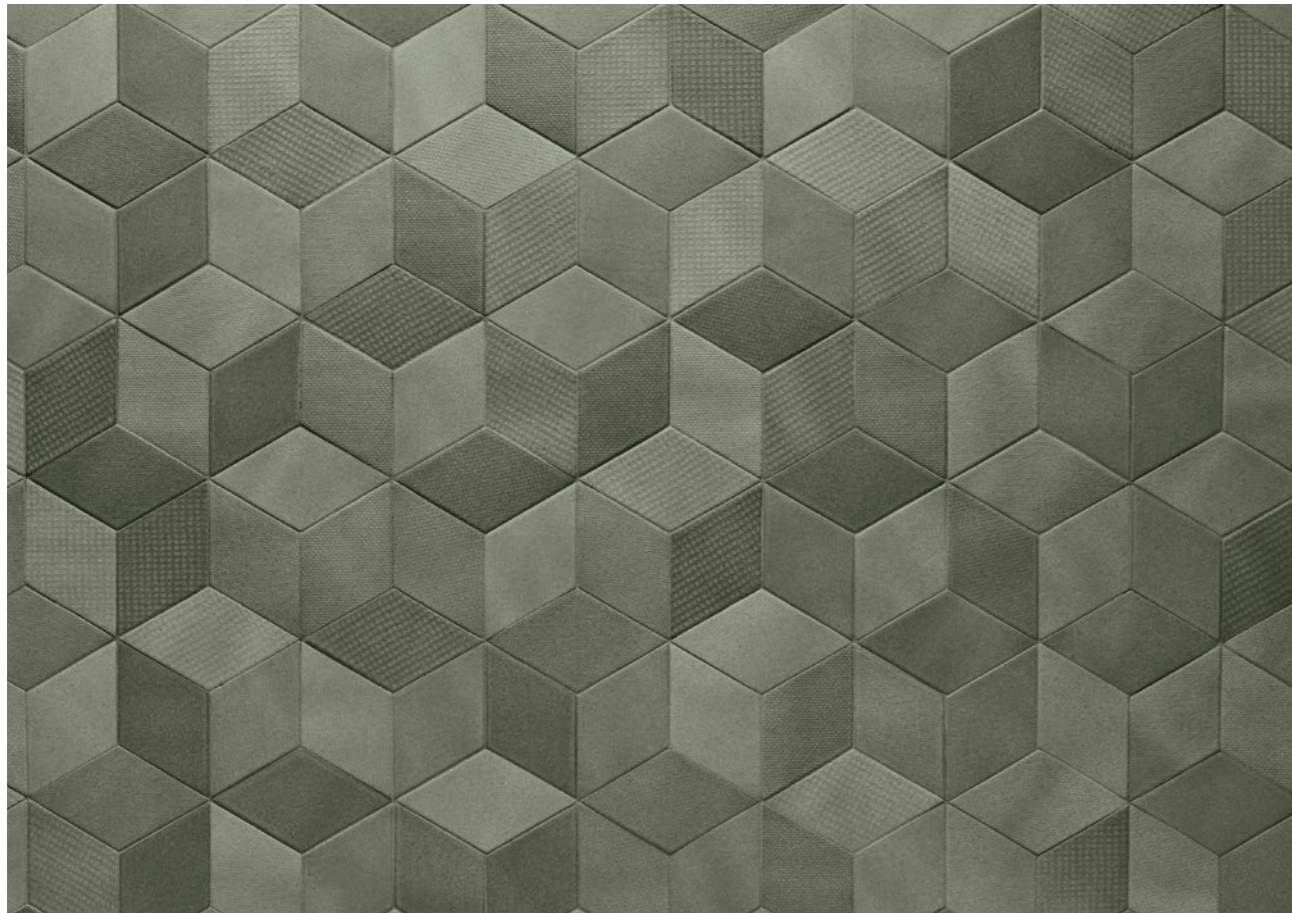

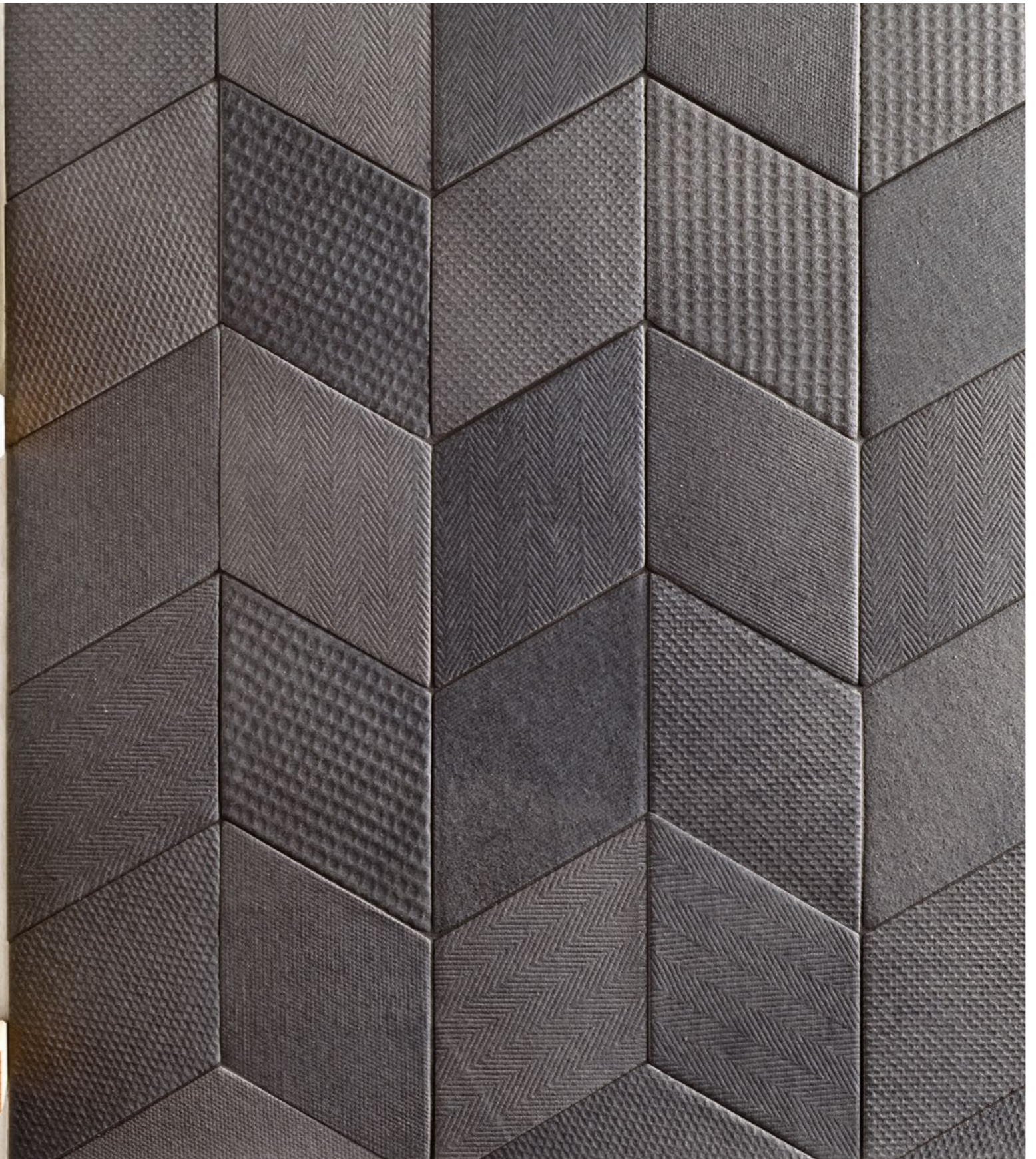

Sizes & Colors

design	Raw Edges	2012
production	industrial	
material	gres porcellanato smaltato glazed porcelain stoneware	
thickness	10 mm	
*	misure nominali/nominal sizes	

Modello depositato n° 002193797-0001/0014 - data di deposito: 28/02/2013
Registered design n° 002193797-0001/0014 - date of registration: 28/02/2013

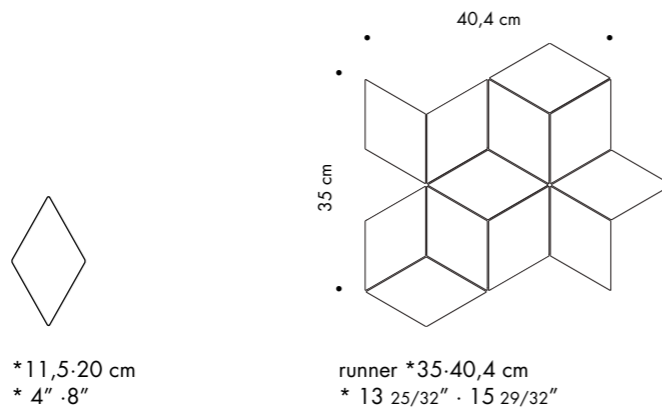

Complementary pieces

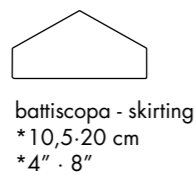

Sizes & Colors

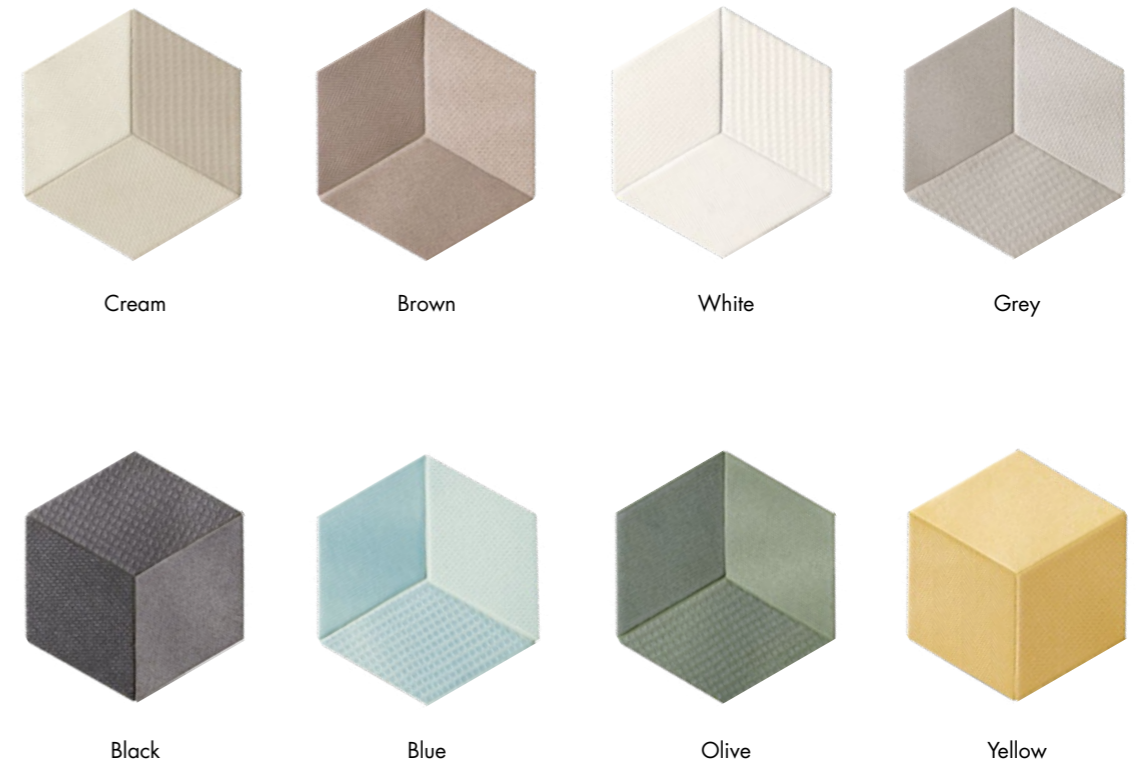

La collezione Tex viene realizzata in gres porcellanato con assorbimento < 0,5% ed è quindi adatta ad un utilizzo sia da pavimento che da rivestimento, in interni ed esterni. Presenta cinque diverse texture ottenute imprimendo sulla superficie dei disegni a rilievo. Viene smaltata attraverso un processo automatico che consente di realizzare per ciascun colore tre toni in ugual percentuale prima di indirizzarla verso un ciclo di cottura in cui si raggiungono temperature fino a 1.200°. Il prodotto così ottenuto presenta una superficie assolutamente opaca, leggermente strutturata ma morbidissima al tatto, facile da pulire perché pensata all'utilizzo sia a rivestimento che a pavimento. Ciascun rombo in formato 11,5x20 cm ed avente spessore 10 mm, pur presentando piccole irregolarità dimensionali volute dai designer, si posa agevolmente con l'impiego di distanziatori da 2 mm e stuccando le fughe in tono su tono.

Tex collection body is realized in porcelain stoneware < 0,5% absorption. This production makes it suitable either for floors and walls, indoor and outdoor. It presents five different textures, obtained by pressing on the surface relief-patterns. The tile is then glazed using an automatic process, which enables the realization in the same percentage of three different shades for each color. The tile finally undergoes a baking process which reaches temperatures up to 1.200°. The obtained product has an absolutely matt surface, slightly structured but very soft to the touch, which is also very easy to clean since thought both for wall and floor covering. Each rhombus in size 11,5x20 cm and with thickness 10 mm, is easily fixed using 2 mm spacers and using a matching grout, even if they have some small size irregularities made on purpose by the designers.

Runner

runner	<p>Il Runner è un elemento composto da 12 rombi di vari colori già posati su rete per la realizzazione facilitata di svariate decorazioni.</p> <p>The Runner is an element composed by 12 rhombus of different colours already set on mesh, so to make the realization of several decors easier.</p>
moduli	<p>Ogni Runner è composto da 8 moduli diversi, non vendibili separatamente ed inclusi in un unico imballo, che permettono di creare molteplici combinazioni.</p> <p>Each Runner is composed by 8 different patterns, not singularly sold and already included in one single package, which enable the realization of many combinations.</p> <p>1 Runner = 8 moduli = 1,12 mq - 1 Runner = 8 patterns = 1,12 sqm</p>
10 runner	<p>Esistono 10 Runner: ognuno abbinato a ciascun colore della collezione, per il colore white ce ne sono 3.</p> <p>There are 10 Runners, each of which combined to every colour of the collection. For the white one there are 3 of them.</p>

Runner

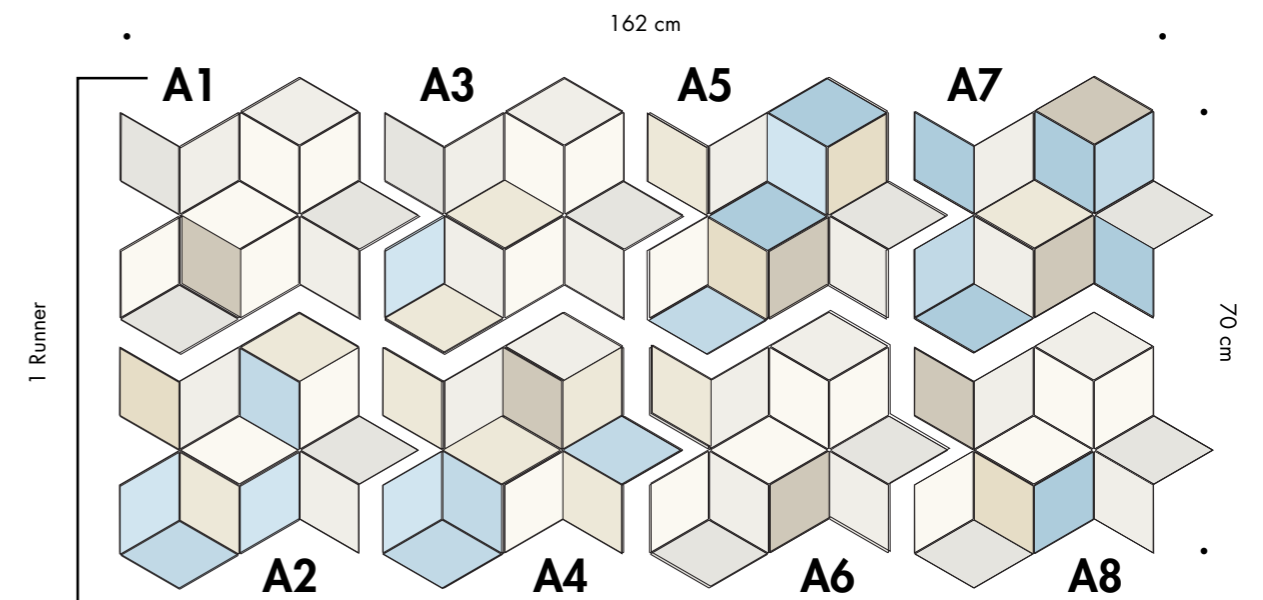
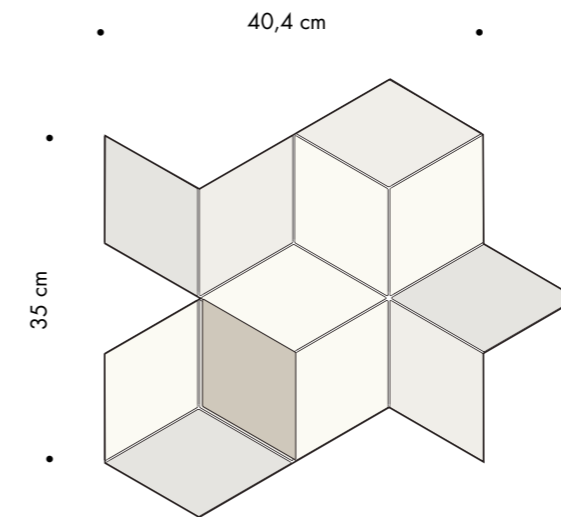

Runner

colours 10 Runner, ognuno composto da 8 moduli diversi, in abbinamento ai colori della collezione.

10 Runners, each of which is composed by 8 different patterns, matching with the colours of the collection.

Runner 1 White
(white + yellow & cream)

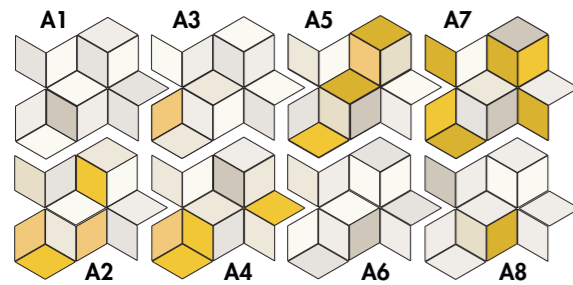

Runner 2 White
(white + olive & cream)

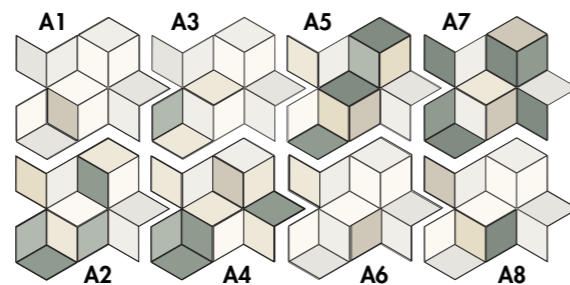

Runner 3 White
(white + blue & cream)

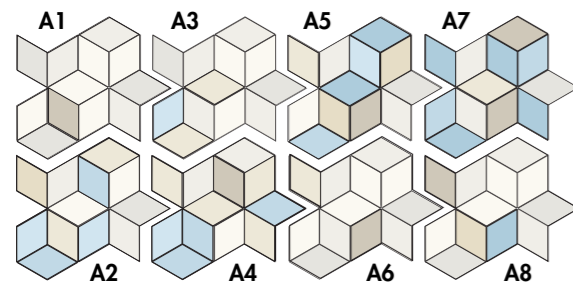

Runner 4 Cream
(cream + brown & white)

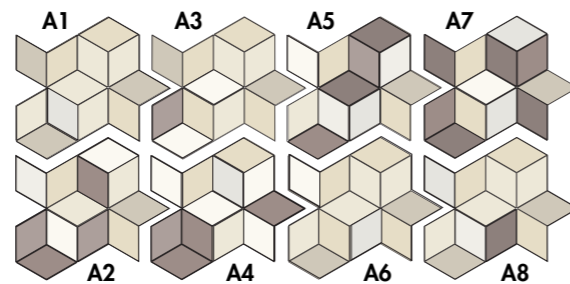

Runner

Runner 5 Brown
(brown + cream & white)

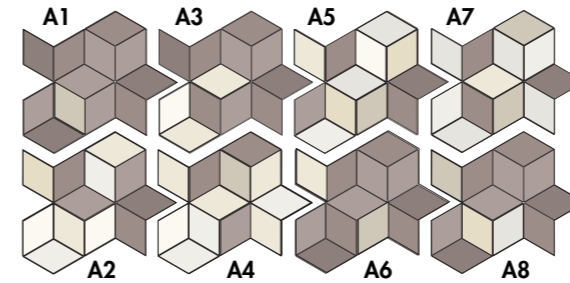

Runner 6 Grey
(grey + cream & white)

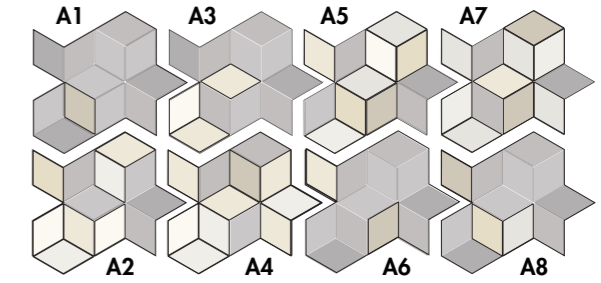

Runner 7 Black
(black + grey & white)

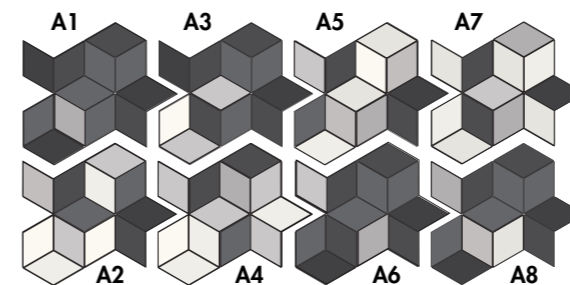

Runner 8 Olive
(olive + cream & white)

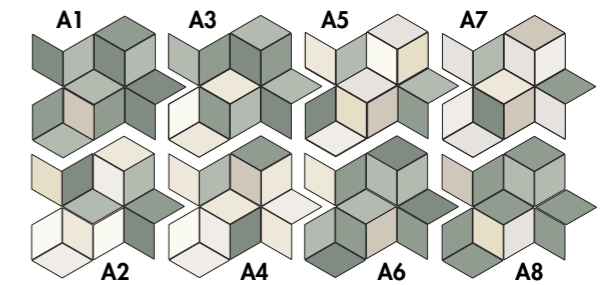

Runner 9 Blue
(blue + cream & white)

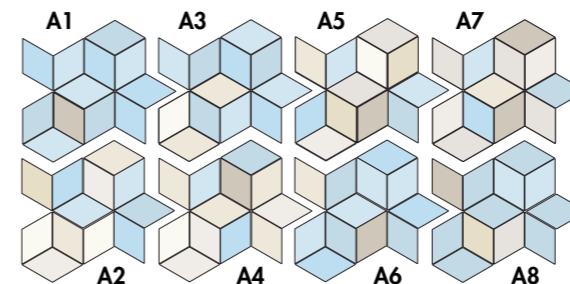

Runner 10 Yellow
(yellow + cream & white)

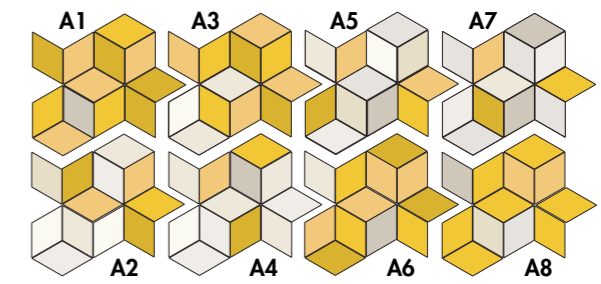

Runner / laying schemes

Esempio di posa 1 / Laying scheme 1
 Composizione singola / Single composition

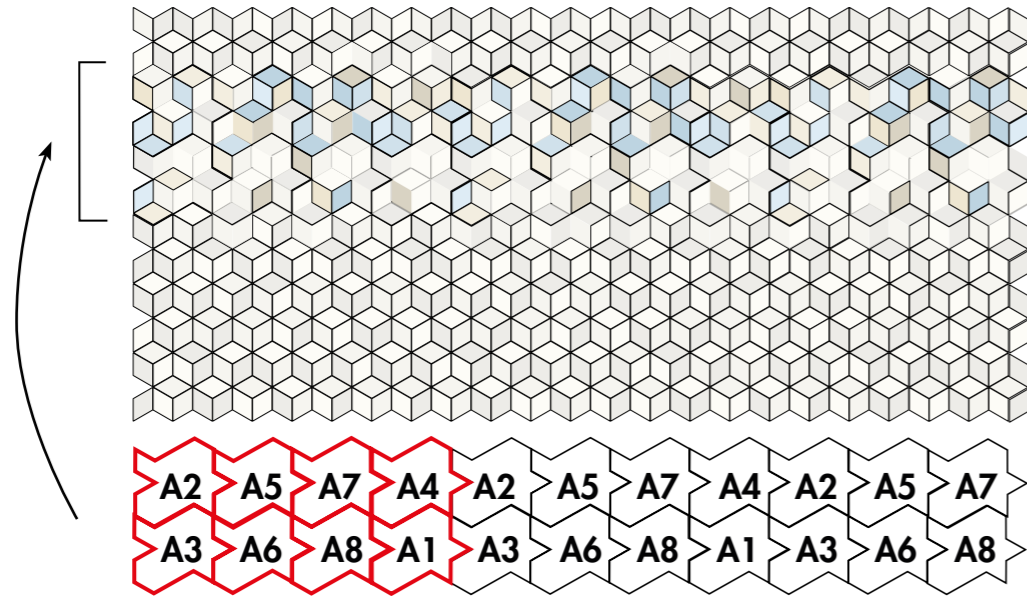

Esempio di posa 2 / Laying scheme 2
 Composizione doppia / Double composition

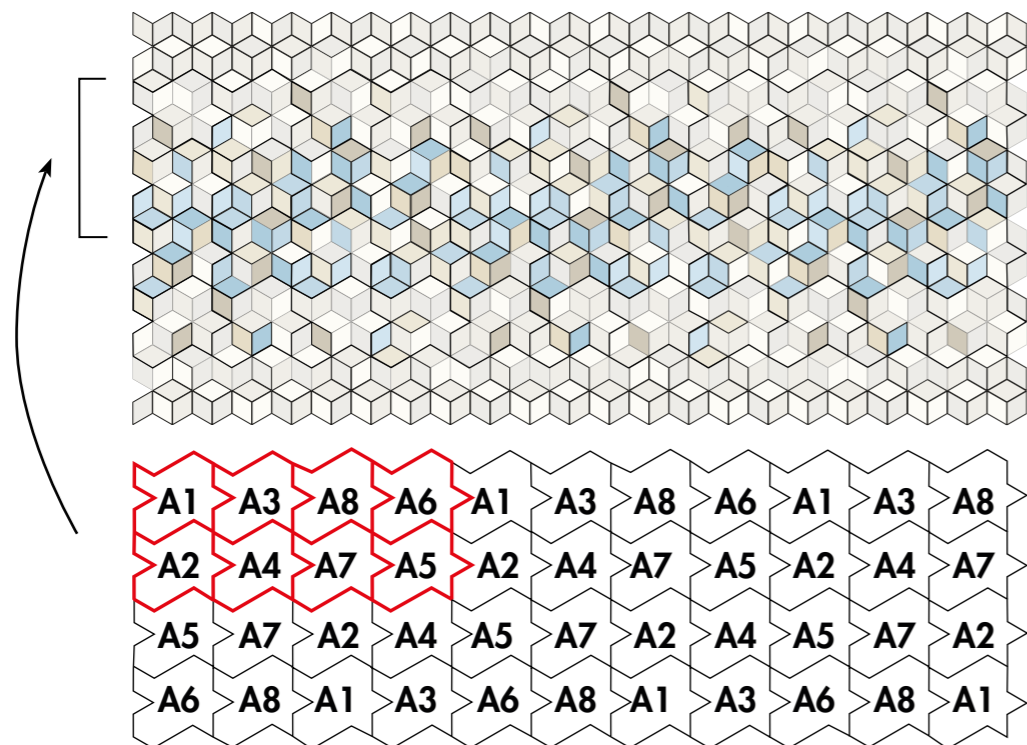

Runner / laying schemes

Esempio di posa 3 / Laying scheme 3
 Composizione libera / Free composition

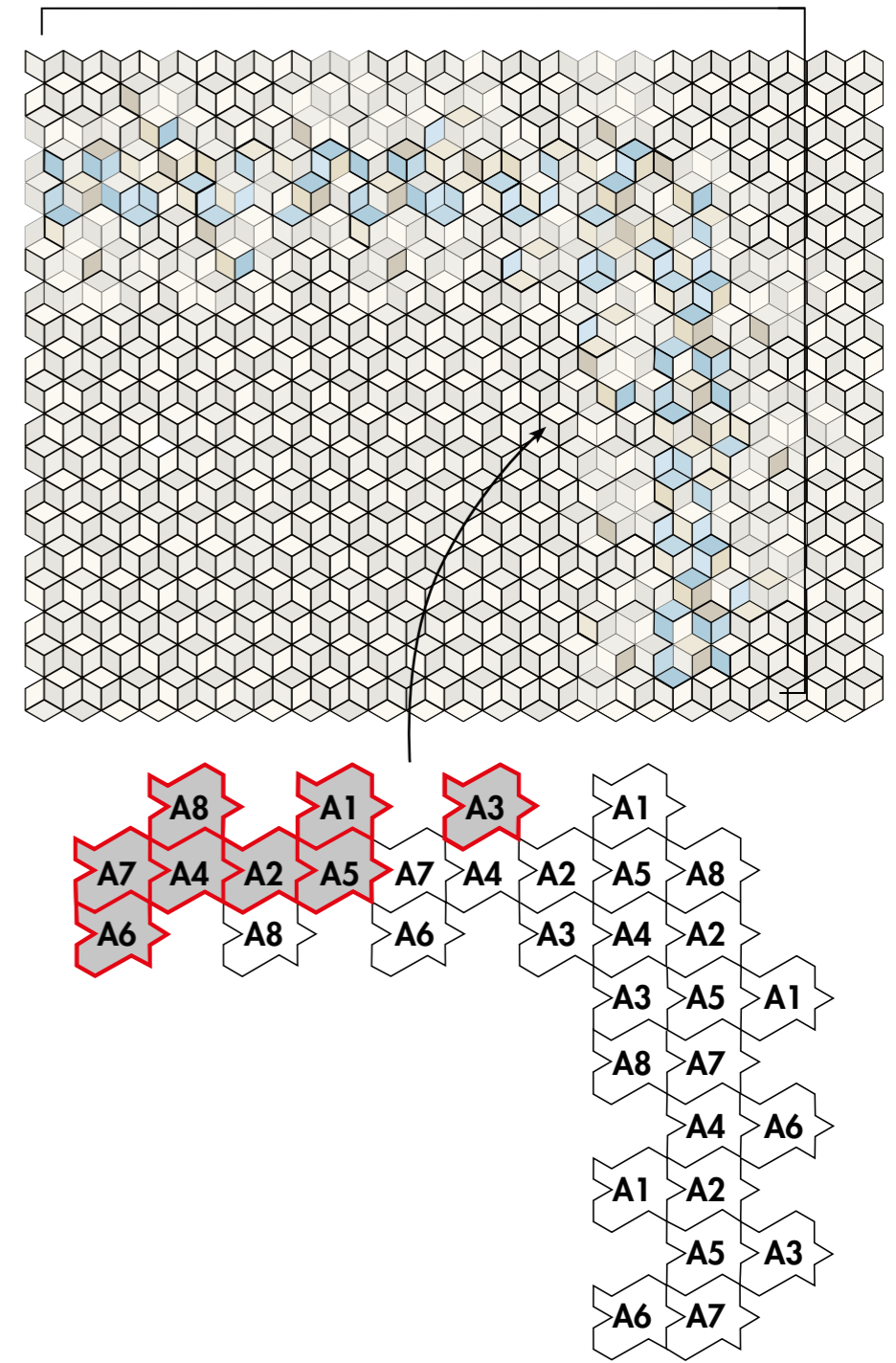

Technical Features

Scan the QR code to download the technical features in other languages



STANDARD	FEATURES	VALUE REQUIRED	TEX
ISO 10545/3	water absorption	< 0,5%	0,04%
ASTM C373		< 0,5%	0,04%
ISO 10545/4	breaking strength	Sp> 7,5 min 1300	resistant
EN 101	surface hardness (scala mohs)	> 5	6
ISO 10545/9	resistance to thermal shock	no visible alteration	resistant
ASTM C484		no samples must show visible defects	unaffected
ISO 10545/12	frost resistance	no alteration	no alteration
ISO 10545/13	resistance to chemical attacks	no visible alteration	resistant
ASTM C650			unaffected
ISO 10545/14	stains resistance	minimum 3	5
DIN 51130-04	slip resistance	medium values 6÷10° R9 10÷19° R10 19÷27° R11 27÷35° R12 > 35° R13	R10
DIN 51097		–	C
DCOF		> 0,42	0,58
Pendulum BS (slip resistance)		–	45 dry - 36 wet
Pendulum AS/NZS 4586-13		–	39 P3
BCRA (anti-slip)		>0,40	dry: 0,53 wet: 0,49
LEED CERTIFICATION 4.1			24% recycled material
Robinson Test		–	extra heavy and high-impact use
VOC Emission			available upon request
Declaration of Contents			available upon request
SDS			available upon request
BPD3			available upon request
HPD			available upon request

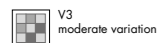

Packing

SIZE	PCS-SQM	PCS-BOX	SQM-BOX	BOX-PAL	KG-BOX	KG-PAL	SQM-PAL
11,5-20 cm	86,96	44	0,51	104	11,56	1202	53,04
runner 35-40,4 cm	0,91 set	1 set (8pcs)	1,12	36	22,55	812	40,32
skirting 10,5-20 cm	–	10	2,00 ml	–	3,25	–	–

Raw Edges



Raw Edges, design studio fondato da Yael Mer e Shay Alkalay, è entrato a far parte del team Mutina nel 2010. Hanno disegnato le collezioni Folded, Folded XL, Tex e Tape.

Nati a Tel Aviv, Yael Mer e Shay Alkalay si sono spostati da Gerusalemme a Londra, dove hanno fondato il Raw Edges Design Studio. Yael ama piegare come fogli sottili strati dei materiali più vari, generando volumi curvi e forme funzionali. Shay ha un profondo interesse per il modo in cui le cose si muovono, funzionano e interagiscono. I due diversi approcci convergono nella creazione di progetti inediti, frutto di una spiccata sensibilità ambientale. Nel 2009 hanno ricevuto l'Elle Decoration International Design Award per Stack di Established & Sons e sono stati insigniti del Designers of the Future Award al Design Miami/Basel. Collaborano con diversi brand internazionali come Cappellini, Established & Sons, Moroso, Kvadrat, Stella McCartney, Arco, Golran, Moustache e Lema. I loro lavori sono presenti nelle collezioni permanenti di musei a livello internazionale.

The Raw Edges design studio, founded by Yael Mer and Shay Alkalay, became part of the Mutina team in 2010. They designed the Folded, Folded XL, Tex and Tape collections.

Both born in Tel Aviv, Yael Mer and Shay Alkalay moved from Jerusalem to London where they founded the Raw Edges Design Studio. Yael likes to fold slim layers of all sorts of material as if they were paper, creating curved volumes and functional forms, while Shay has a passionate interest in the way things move, function and interact. These two different approaches combine in the creation of original projects, characterised by a keen sensitivity towards the environment. In 2009 they received the Elle Decoration International Design Award for Stack by Established & Sons and the Designers of the Future Award in the furniture section at Design Miami/Basel. They work with a number of international brands and producers, such as Cappellini, Established & Sons, Moroso, Kvadrat, Stella McCartney, Arco, Golran, Moustache and Lema. Their work is part of the permanent collections in several international museums.

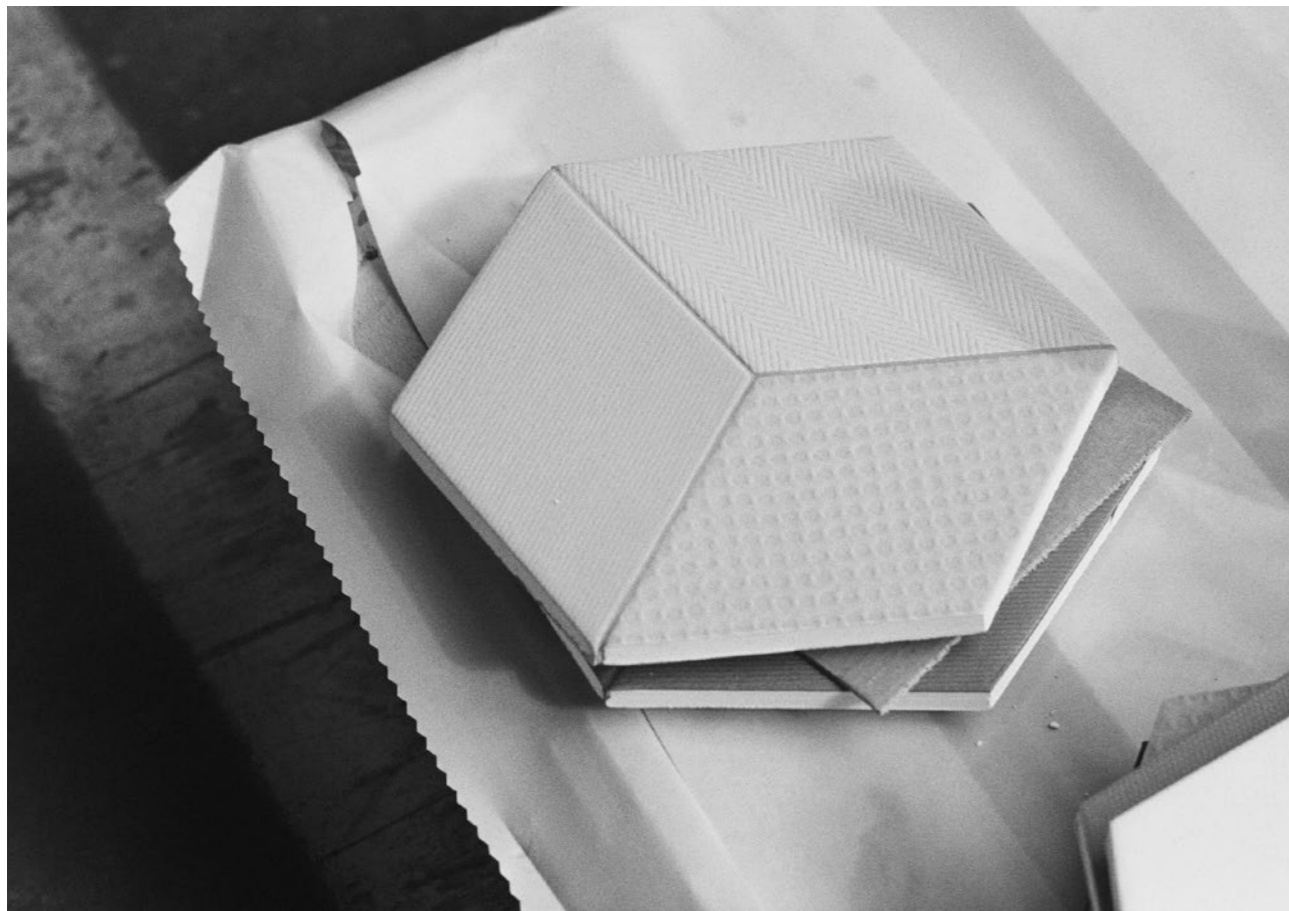

La produzione di Tex esalta la varietà delle texture, l'autenticità dei colori e le qualità tattili dello smalto. Inoltre la verniciatura colorata e naturale applicata alla ceramica crea una lucentezza irregolare in alcuni luoghi e più satura in altri.

The production of Tex enhances a large multiplicity of textures, the variety of colors and the tactile qualities of the glaze. In addition, the colorful and natural glaze applied on ceramic creates an irregular effect in certain places, while a more saturated one in others

Yael Mer & Shay Alkalay



CREDITS

Art direction: Alla Carta Studio
Graphic design: Matteo Pastorio
Text: Raw Edges
Photography: Alessandro Paderni / EYE Studio
Gerhardt Kellermann (p. 21)
Set design: Raw Edges
January 2022.

Thanks to:

Arco
Cappellini
Fantini
Il te delle 5
Alessandro Pietri

All the rights are reserved.
Not any part of this work can be reproduced
in any way without the preventive written
authorization by Mutina. All work is
copyrighted © to their respective owners.

To discover more about Mutina
collections visit mutina.it

Ceramiche Mutina Spa
Via Ghiarola Nuova 16
41042 Fiorano MO, Italia
T +39 0536812800
F +39 0536812808
info@mutina.it
www.mutina.it

© Mutina 2022



