

WELLNESS

**BATHTUBS
2023**



WELLNESS

BATHTUBS

- 2 **WHY CHOOSE
A NOVELLINI BATHTUB**
- 4 **MATERIALS AND DESIGN**
- 8 **OUR MASSAGE SYSTEMS**
- 11 **OUR WELLNESS FUNCTIONS**
- 12 **OUR BATHTUB COLLECTIONS**
- 15 **STYLE**
ASSERTIVE STYLE AND HIGH-PERFORMANCE
MASSAGES
- 23 **DIVINA**
DESIGN AND PLEASURE
- 41 **DIVINA DUAL**
BATHTUB FOR 2 PERSONS SIDE BY SIDE
- 45 **SENSE 2.0**
VARIETY OF JETS AND FULL BODY
MASSAGES
- 55 **SENSE DUAL**
TWO-SEATER BATHTUB FACING EACH OTHER
- 59 **CLASSIC**
INTRODUCTION TO BATH MASSAGES
- 63 **CONFORT**
BATH AND SHOWER ALL-IN-ONE
- 69 **NOVOTECH**
EXCLUSIVE DESIGN AND NOBLE MATERIALS

WHY CHOOSE A BATHTUB NOVELLINI

MADE IN
ITALY



100% MADE IN ITALY

All our products are manufactured in our factory in Mantua, Italy. The control of the entire production line allows us to ensure the highest level of quality of the finished products and components used.

CUSTOMER SERVICE CLIENT

Our team works daily to offer customised solutions to your requests and answer your questions. With our commitment to improving the quality of our services, we are committed to providing technical support to all our customers and users of our products.

LOCATION / Borgo Virgilio - Mantua - Italy



KNOW-HOW

With a proud history of over 50 years, Novellini has become a leading brand in the European bathroom market, popular with professionals and consumers alike. From the very beginning, we have relied on the best technologies and the latest design trends to provide you with a unique experience of well-being.

EQUIPMENTS

Depending on the version, your bathtub will be delivered with all the necessary equipment for its installation: feet or self-supporting frame, headrest cushions, automatic drain, tapware or filling system through the drain. All our baths are available with or without whirlpool massage.

NORMS

All our products are designed and manufactured to comply with the latest European quality and safety standards. From the raw materials to the finished products, including the assembly of the various components, each phase is carefully planned, checked and verified to guarantee characteristics that meet the maximum standards required by the European authorities.



MATERIALS

**WE USE THE HIGHEST QUALITY MATERIALS
SO THAT YOUR BATHTUB CAN GIVE YOU COMPLETE
SATISFACTION**

SYNTEK

This reinforced synthetic material allows us to create a wide variety of designs. It is pleasant to the touch and easy to care for, has excellent insulating properties and provides exceptional comfort as it quickly adopts the temperature of the bath water. The surface of Syntek is naturally non-slip and guarantees an optimal grip. Tested with a degree of inclination greater than 18° for the glossy white finish and 24° for the matt white finish, our bathtubs meet the PN18 and PN24 standards respectively. Available with the Divina, Sense, Classic and Comfort collections.



glossy white
classic

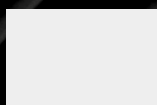

matt white
exclusive, with a soft and silky appearance

NOVOTECH

Extremely solid and highly aesthetic, this exclusive material contains a high percentage of natural mineral fillers and high purity resins. Thanks to its extraordinary qualities, it allows us to create organic and sinuous shapes with a dynamic and sensual STYLE. The solidity of Novotech gives maximum stability to the island baths. Its smooth and silky appearance is a real delight to the touch. Available with the Novotech collection.



matt white

TABLIERS

We offer a wide range of apron finishes to give your bathroom a traditional or new look. Our aprons are water resistant and have a solid design that ensures they will last for years. The aprons are available in finishes that match our furniture collections.

SYNTEK LAMINATE, MATCHES THE FINISH OF THE BATHTUB



white glossy

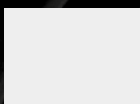

matt white

5 VARIANTES DE WOOD



white wood



grain



burlington

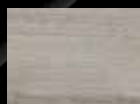

dolomite

MDI

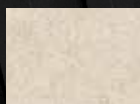

sabbia



umbra

4 NATURAL CLAY COLOURS

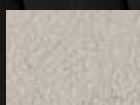

Polvere



Tortora



Cenere

4 NATURAL CLAY COLOURS ON REQUEST



cipria

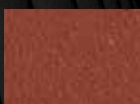

tegola



alga



senape



DESIGN

THE DESIGN AND VISUAL PLEASURE CONTRIBUTE TO YOUR WELL-BEING.

THAT IS WHY WE CALL ON THE BEST DESIGNERS TO DEVELOP THE SHAPES AND ERGONOMICS OF OUR BATHTUBS.

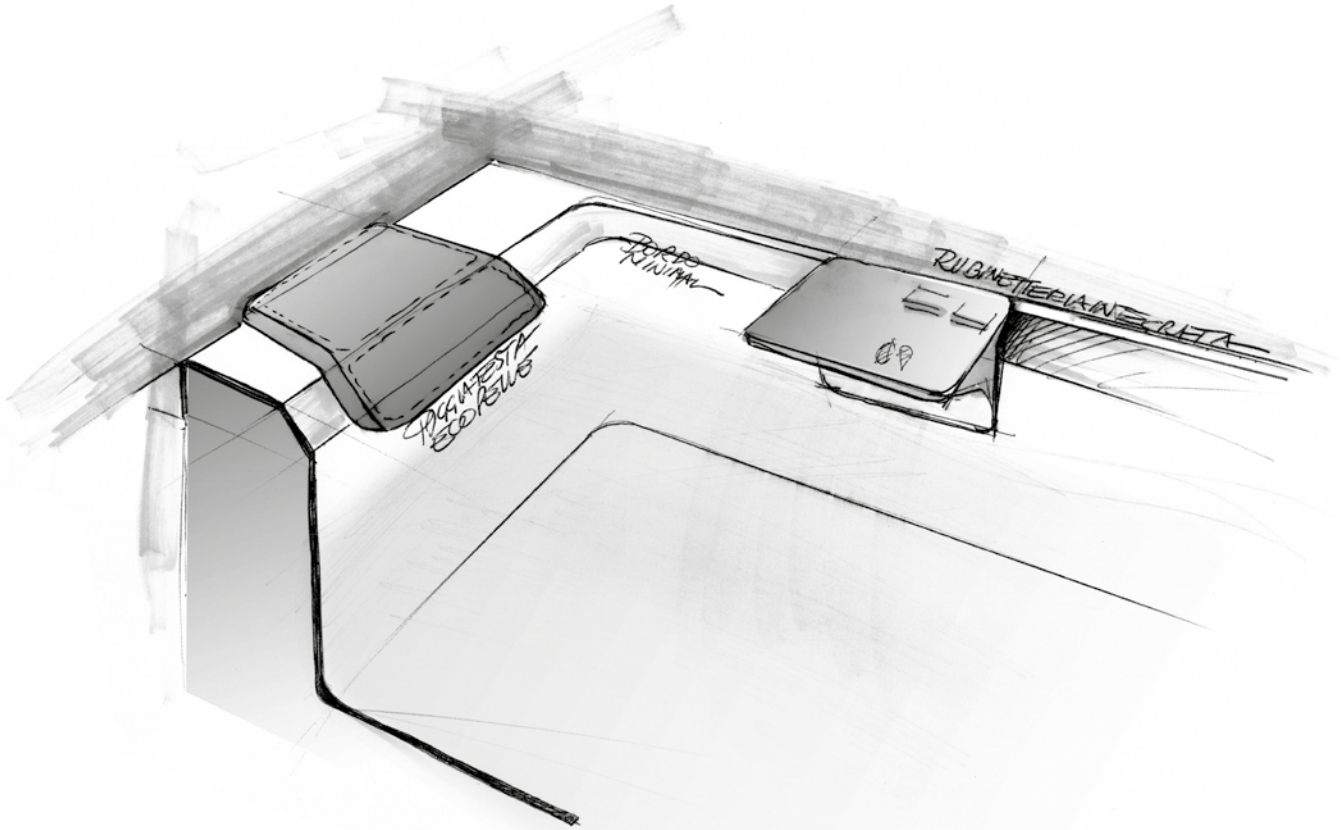

MARCO PELLICI
DESIGNER



SIMONE MICHELI
DESIGNER



MASSIMO FARINATTI
DESIGNER



We bring Made in Italy design excellence to the centre of your bathroom space. Our designers conceive environments and individual elements in such a way that you feel well from the very first glance. Concepts of comfort and ergonomics are combined with STYLE and aesthetic vision to create the bathroom of your dreams.

ALL THE PLEASURES OF MASSAGE

Our range of massages
will satisfy your desires.

Relax, tone up or take care of your skin
Among our MASSAGE SYSTEMS,
you will certainly find the one that will perfectly
meet your
your wellness needs.





SILENCE

A whirlpool bath is a privileged moment that allows you to devote yourself fully to your well-being. This is why we pay particular attention to sound comfort. The pumps and blowers of our baths are designed to preserve serenity during your bathing sessions and let you be lulled by the gentle sound of moving water.



YOUR WELL-BEING IN A SINGLE GESTURE

Whichever collection you choose, you'll love how easy it is to use the massages. We have designed our keypads and remote controls to give you easy access to all the functions.

OUR MASSAGE SYSTEMS



AIRPOOL

*Are you looking for a relaxing solution?
> Opt for **Air** massages.*

The air caresses the body and has a gentle relaxing effect. The air bubbles give you a feeling of lightness, fight fatigue and reduce stress. The air is projected through the injectors in the bottom of the bathtub.



WHIRLPOOL

*Do you prefer WHIRLPOOL and stimulating massages?
> Turn to **water** massages.*

Water provides a deep massage that improves blood circulation and reduces muscle tension. Water massages eliminate toxins and help to firm the skin. The intensity of the water massage can be adjusted by means of jets on the vertical walls of the bathtub, which are connected to a pump.

TAKING CARE OF YOUR BATH

It is important to take CARE of your bathtub to enjoy its benefits for many years.



AUTOMATIC DEWATERING

All of our Air systems are equipped with an automatic drying system which is activated when the bathtub is emptied to purge the air circuits and remove any water residues and impurities.



DISINFECTION

It is essential to clean the water pipes of your bath regularly (every 8 to 10 uses). To do this, we recommend using products that are suitable for whirlpools and that protect the equipment. Rinse your bathtub, fill it with water, add the disinfectant and start the disinfection programme or simply a water massage if your bathtub does not have a special programme.





AIRPOOL AND WHIRLPOOL

*Would you like to enjoy all the benefits of BATHtherapy?
> Treat yourself to the **Mixte** system massages.*

The combination of the water and air systems, the mixed massage fulfils all your wellness needs and offers you the relaxing benefits of air and the invigorating properties of water. The bathtub has water Jets on the vertical walls and air injectors at the bottom.



NATURAL AIR

*Would you like to give your skin a rejuvenating bath?
> Our exclusive **Natural Air** care system is for you.*

The Natural Air system combines the pleasures of a relaxing bath with skin care. Thousands of micro-bubbles of air mix with the water jet and form a delicate cloud of oxygen that cleanses the skin and improves its elasticity. One or two micro-bubble diffusers are placed on the walls of the bathtub.



NATURAL AIR AND WHIRLPOOL

*Do your desires change according to the rhythm of your life?
> Our **Natural Air+Whirlpool** system will perfectly match your needs.*

The Natural Air treatment will revitalise your skin, while the Whirlpool Water massages will tone and energise your body. It is up to you to decide whether you want a relaxing break or a deep massage session, depending on your mood. The bathtub has water Jets on the side walls and one or two micro air bubble diffusers.

TECHNOLOGY NATURALAIR

The micro air bubbles, up to 100 times smaller than the air bubbles produced by an air system, saturate the water, transforming it into a soft mixture and giving it the appearance of a delicate milk bath.

They adhere to the skin, removing impurities, dead cells and sebum. The soft feeling on the skin lasts all day and a session of only 20 minutes is enough to obtain the maximum benefit.

The oxygen released by the Natural Air system stimulates the production of collagen, an important protein in our body, which plays an essential role in the functioning of organs and tissues. Collagen augmentation is a natural anti-ageing remedy that reduces wrinkles and smoothes your skin to restore its vitality.





THERE IS NO NEED
TO TRAVEL THE WORLD
TO FIND
INNER PEACE.

YOU CAN FIND YOUR HAVEN OF PEACE AT HOME.
DIVE INTO YOUR BATH AND LET THE MAGIC OF THE WATER WORK.
A 15-20 MINUTE SESSION IS ENOUGH TO RESTORE YOUR SERENITY
AND RESTORE YOUR VITAL FORCES.

WELL-BEING

TO MAKE EACH OF YOUR WHIRLPOOL SESSIONS UNIQUE, OUR BATHTUBS OFFER YOU THE FUNCTIONS THAT WILL TAKE YOU INTO A REAL BUBBLE OF WELL-BEING

MUSIC

Listen to your favourite music during your bath.

Bluetooth

The Bluetooth connection allows you to connect your smartphone, tablet or PC to the bathtub to play your playlists. You can control your music from your playback device. Bluetooth technology is used in the Divina and Sense bathtubs.

Radio RDS

Stay tuned to your favourite radio programmes! You can manage your radio channels from the remote control. The RDS radio function is available with Sense bathtubs.



























CHROMOLIGHT

Liven up your moments of relaxation with multicoloured lights diffused in the bath water. Relaxing, energizing or enchanting... you can let the colours pass by or choose the colour you prefer.



OUR COLLECTIONS

EACH OF OUR BATHTUB COLLECTIONS
REFLECTS A PARTICULAR APPROACH TO WELL-BEING

			
	<p>STYLE STRONG STYLE AND PERFORMANCE p. 15</p>	<p>DIVINA & DIVINA DUAL DESIGN AND PLEASURE p. 23</p>	<p>SENSE 2.0 VARIETY OF JETS AND FULL BODY MESSAGES p. 45</p>
	<p> STYLE</p> <p> STYLE C</p>	<p> DIVINA 35</p> <p> DIVINA F 35</p> <p> DIVINA O</p> <p> DIVINA W</p> <p> DIVINA C</p> <p> DIVINA DUAL</p>	<p> SENSE 3 2.0</p> <p> SENSE 4 2.0</p>
BATHTUB MATERIAL	Syntek glossy white matt white	Syntek glossy white matt white	Syntek glossy white matt white
MASSAGE SYSTEMS	<p>AIRPOOL Hydro Air</p> <p>WHIRLPOOL Whirlpool Whirlpool+Disinfection+Light</p> <p>AIRPOOL + WHIRLPOOL Hydro Plus</p> <p>NATURAL AIR + WHIRLPOOL Natural Air + Whirlpool</p>	<p>AIRPOOL Hydro Air (except Divina Dual)</p> <p>WHIRLPOOL Whirlpool</p> <p>AIRPOOL + WHIRLPOOL Hydro Plus</p> <p>NATURAL AIR Natural Air (except Divina Dual)</p> <p>NATURAL AIR + WHIRLPOOL Natural Air + Whirlpool</p>	<p>AIRPOOL Dream Air</p> <p>WHIRLPOOL Whirlpool+Disinfection Whirlpool+Disinfection+Light</p> <p>AIRPOOL + WHIRLPOOL Hydro Plus</p> <p>NATURAL AIR + WHIRLPOOL Natural Air + Whirlpool</p>
WELLNESS FUNCTIONS (depending on the system)	<p> (depending on the system)</p> <p> Bluetooth</p>	<p> Water jets backlit</p> <p> Bluetooth</p> <p> Heater-stabiliser (Divina Dual)</p>	<p> Backlit water jets or spotlight</p> <p> Bluetooth</p> <p> Heater -water temperature stabiliser (Hydro Plus)</p>
CONTROL	 Keyboard keypad	 Integrated touch-sensitive keypad at the edge of the bathtub	 Keyboard keypad



SENSE DUAL
TWO-SEATER BATHTUB
FACING EACH OTHER
p. 55

CLASSIC
INITIATION TO
BATH MESSAGES
p. 59

CONFORT
BATH & SHOWER
ALL-IN-ONE
p. 63

NOVOTECH
EXCLUSIVE DESIGN
AND NOBLE MATERIALS
p. 69



SENSE DUAL



CALOS 2.0



IRIS



INFINITIVE



SHIP

Syntek
glossy white
matt white

Syntek
glossy white
matt white (Calos 2.0)

Syntek
glossy white



Novotech

AIRPOOL + WHIRLPOOL
Hydro Plus

WHIRLPOOL
Hydro / Hydro+Disinfection

AIRPOOL + WHIRLPOOL
Hydro Plus

NATURAL AIR
Natural Air

-  Peripheral LED line
-  Bluetooth + Radio RDS
-  Heater - water temperature stabiliser



**DEPTH
50 CM FOR
OPTIMAL
IMMERSION**



COLLECTION **STYLE**

STYLE AND EFFICIENT MESSAGES

This brand new line of bathtubs surprises with its clean lines and soft curves. The interior volumes are designed to provide you with the best comfort. The powerful water and air massages will help you rediscover the natural sensations of water.



The round water jets can be turned in different directions and allow the areas of the body that need to be stimulated to be targeted. The jets are finished to match the bathtub. The inside of the jets and their contour are backlit in the Whirlpool+Disinfection+Light, Hydro Plus and Natural Air +Whirlpool versions.



The ergonomic control panel provides easy access to all functions of your BATH. The finish matches that of the BATH. A simple touch is all it takes to access your favourite massages.



The bathtubs have a large surface for bath products and taps.



In order to assert its strong character, this line of BATHS offers a wide choice of aprons: HPL panels in WOOD or CLAY finishes, and a real innovation, the MDi cladding panels with a natural look. The Frame frame can be added to these panels.

STYLE

RECTANGULAR BATHTUB

VERSIONS

EQUIPMENT

TO BE INSTALLED WITH FEET

WITH CHASSIS SELF-SERVING

headrest emptying

		STANDARD WITHOUT SYSTEM BATH	AIRPOOL AIR SYSTEM HYDRO AIR	WHIRLPOOL WATER SYSTEM WHIRLPOOL	WHIRLPOOL WATER SYSTEM WHIRLPOOL + DISINFECTION + LIGHT	AIRPOOL + WHIRLPOOL MIXED SYSTEM HYDRO PLUS	NATURAL AIR + WHIRLPOOL MICRO-BUBBLE AIR + WATER SYSTEM NATURAL AIR + WHIRLPOOL
TO BE INSTALLED WITH FEET		•					
WITH CHASSIS SELF-SERVING	headrest emptying	•	•	•	•	•	•

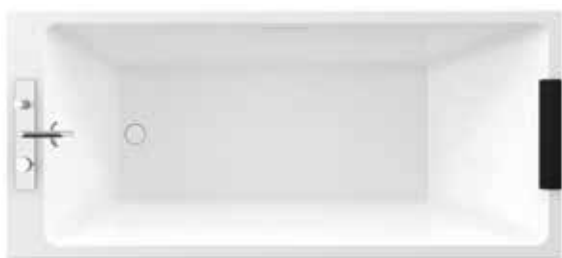

Glossy white White mat

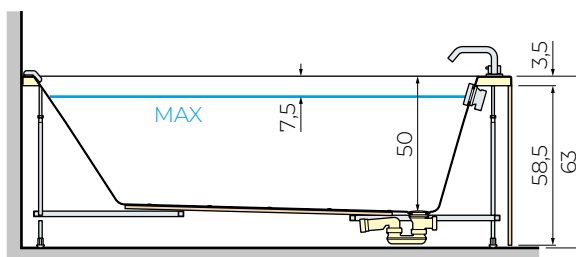
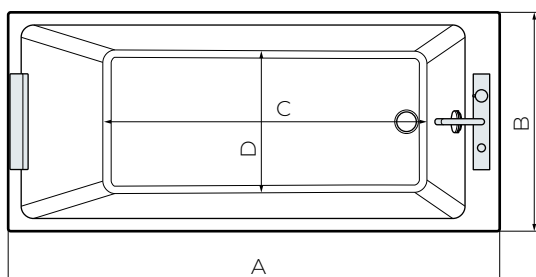

MODEL	A	B	C	D	CAPACITY
170x70 cm	170 cm	70 cm	108 cm	42 cm	260 litres
170x75 cm	170 cm	75 cm	108 cm	47 cm	280 litres
180x80 cm	180 cm	80 cm	118 cm	52 cm	330 litres
180x110 cm	180 cm	110 cm	118 cm	82 cm	500 litres
190x90 cm	190 cm	90 cm	128 cm	62 cm	410 litres

OPTIONS

Fittings, overflow filling, Aprons for installation in a niche, corner, U-shaped against a wall or in a batch.

HPL TABLES FOR WHITE, CLAY OR WOOD FINISHES

WHITE to match the bathtub		CLAY			WOOD				MDI	
GLOSSY WHITE	WHITE MAT	CENERE	TORTORA	POLVERE	WHITE WOOD	GRAIN	BURLINGTON	DOLOMITE	SABBIA	UMBRA

CAN BE COMBINED WITH :

- BLACK FRAME
- BLACK FRAME WHITE FRAME
- BLACK FRAME WHITE FRAME
- BLACK FRAME WHITE FRAME
- BLACK FRAME WHITE FRAME
- BLACK FRAME WHITE FRAME
- BLACK FRAME WHITE FRAME
- BLACK FRAME WHITE FRAME
- BLACK FRAME WHITE FRAME
- BLACK FRAME WHITE FRAME
- BLACK FRAME WHITE FRAME

4 NATURAL CLAY COLOURS ON REQUEST

CLAY			
CIPRIA	TEGOLA	ALGA	SENAPE



BATHTUB EDGE FITTINGS

Constant flow, variable temperature. Hand shower with anti-drip hose. Finishes: chrome or black.

STYLE



STYLE C

CORNER BATHTUB

Edge height 3,5 cm

VERSIONS

EQUIPMENT

TO BE INSTALLED WITH FEET

WITH CHASSIS SELF-SERVING

headrest emptying

STANDARD WITHOUT SYSTEM BATH	RELAX AIR SYSTEM (AIRPOOL) HYDRO AIR	TONIQUE WATER SYSTEM WHIRLPOOL	TONIQUE MASSAGGIO ARIA / ACQUA WHIRLPOOL + DISINFEZIONE + LIGHT	RELAX + TONIQUE MIXED SYSTEM HYDRO PLUS	CURA + TONIQUE MIXED SYSTEM NATURAL AIR + WHIRLPOOL
•					
•	•	•	•	•	•



Glossy white

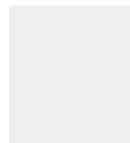

White mat

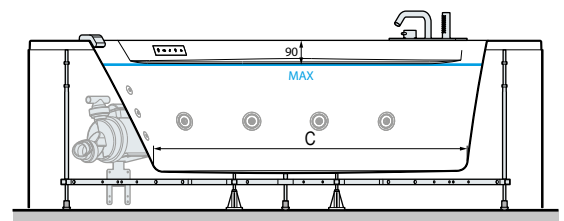
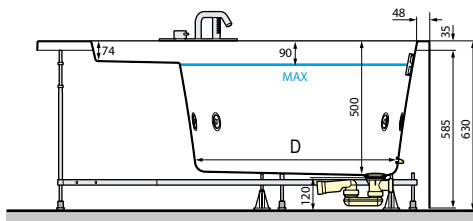
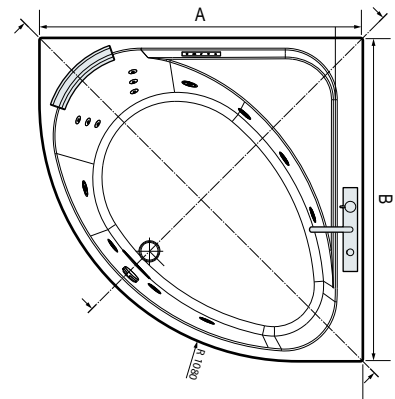

OPTIONS

Fittings, overflow filling, Aprons for installation in a niche, corner, U-shaped against a wall or in a batch.

MODEL	A	B	C	D	CAPACITY
135x135 cm	135 cm	135 cm	116,3 cm	74,8 cm	310 litres

HPL TABLES FOR WHITE, CLAY OR WOOD FINISHES

WHITE
to match the bathtub



GLOSSY WHITE WHITE MAT

CLAY

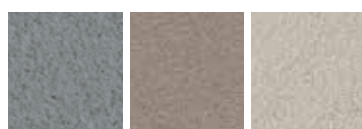

CENERE TORTORA POLVERE

WOOD



WHITE WOOD GRAIN BURLINGTON DOLOMITE

4 NATURAL CLAY COLOURS ON REQUEST

CLAY

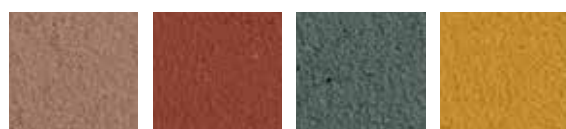

CIPRIA TEGOLA ALGA SENAPE



BATHTUB EDGE FITTINGS

Constant flow, variable temperature. Hand shower with anti-drip hose. Finishes: chrome or black. (on request)

STYLE C



MASSAGE SYSTEMS

AIRPOOL

HYDRO AIR

Air massage system
 - 6 back air injectors
 + 10 bottom air injectors
 400 W

 Continuous air massage or alternating

STYLE

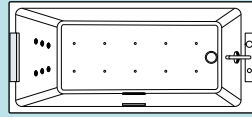

STYLE C

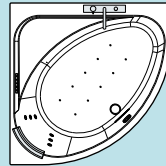

HYGIENE

AIR: Drying of air ducts at the end of the bath

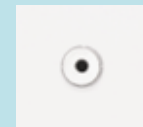

Air injector

WHIRLPOOL

WHIRLPOOL

Water massage system
 - 6 side water Jets
 550 W

 Water massage, possibility of adjusting the intensity of the massage for each jet

STYLE



STYLE C

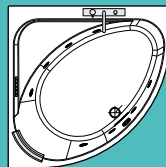

HYGIENE

WATER: Use products for whirlpool baths to disinfect the bathtubs to disinfect the water circuit: fill your bathtub bathtub, pour the product into the bath water and start the water massage.





Adjustable water jet

WHIRLPOOL

WHIRLPOOL + DISINFECTION + LIGHT

Water massage system
 - 6 side water jets
 550 W

 Water massage, possibility to adjust the intensity of the massage for each jet

 Chromolight: backlit jets with multicolour light diffusion with the possibility of stopping on a colour

 Playback of music stored on a phone or tablet via Bluetooth connection

 Disinfection programme

STYLE

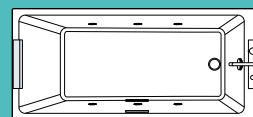

STYLE C

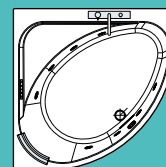

HYGIENE

WATER: Disinfection programme for water pipes. Use products suitable for whirlpool baths to fill the reservoir provided for this purpose.

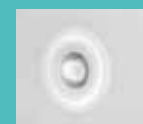





Adjustable water jet

AIRPOOL AND WHIRLPOOL

HYDRO PLUS

Mixed massage system
 - 10 air injectors at the bottom 400 W
 - 6 adjustable water Jets on the side
 + 2 adjustable water Jets on the foot
 + 6 micro water Jets on the back
 900 W

-  Continuous or alternating air massage
-  Water massage, possibility to adjust the intensity of the massage for each jet
-  Chromolight: backlit jets with multicolour light diffusion with the possibility of stopping on a colour
-  Playback of music stored on a phone or tablet via Bluetooth connection
-  Disinfection programme

STYLE

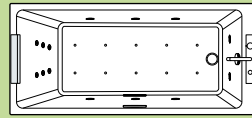

STYLE C

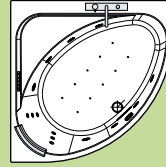

HYGIENE

AIR: Drying of air ducts at the end of the bath

WATER: Disinfection programme for pipes Water. Use products suitable for whirlpool baths to fill the reservoir provided for this purpose.

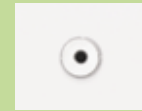

Air injector







Adjustable water jet

NATURAL AIR AND WHIRLPOOL

NATURAL AIR + WHIRLPOOL

Water massage system with micro-bubble air diffusion
 - 6 backlit side water Jets 550 W
 - 1 Natural Air diffuser
 1 050 W

-  Diffusion of micro air bubbles in the bath water On/off operation
-  Water massage, possibility to adjust the intensity of the massage for each jet
-  Chromolight: backlit jets with multicolour light diffusion with the possibility of stopping on a colour
-  Playback of music stored on a phone or tablet via Bluetooth connection
-  Disinfection programme

STYLE



STYLE C

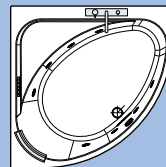

HYGIENE

WATER: Disinfection programme for pipes Water. Use products suitable for whirlpool baths to fill the reservoir provided for this purpose.



Natural Air Diffuser



Adjustable water jet



MUSIC BLUETOOTH

diffusion of music stored on external devices **resonating** through the the walls of the bath.



BACKLIT JETS

light sequences to animate your whirlpool sessions (except for Whirlpool system)

**DEPTH
50 CM FOR
OPTIMAL
IMMERSION**

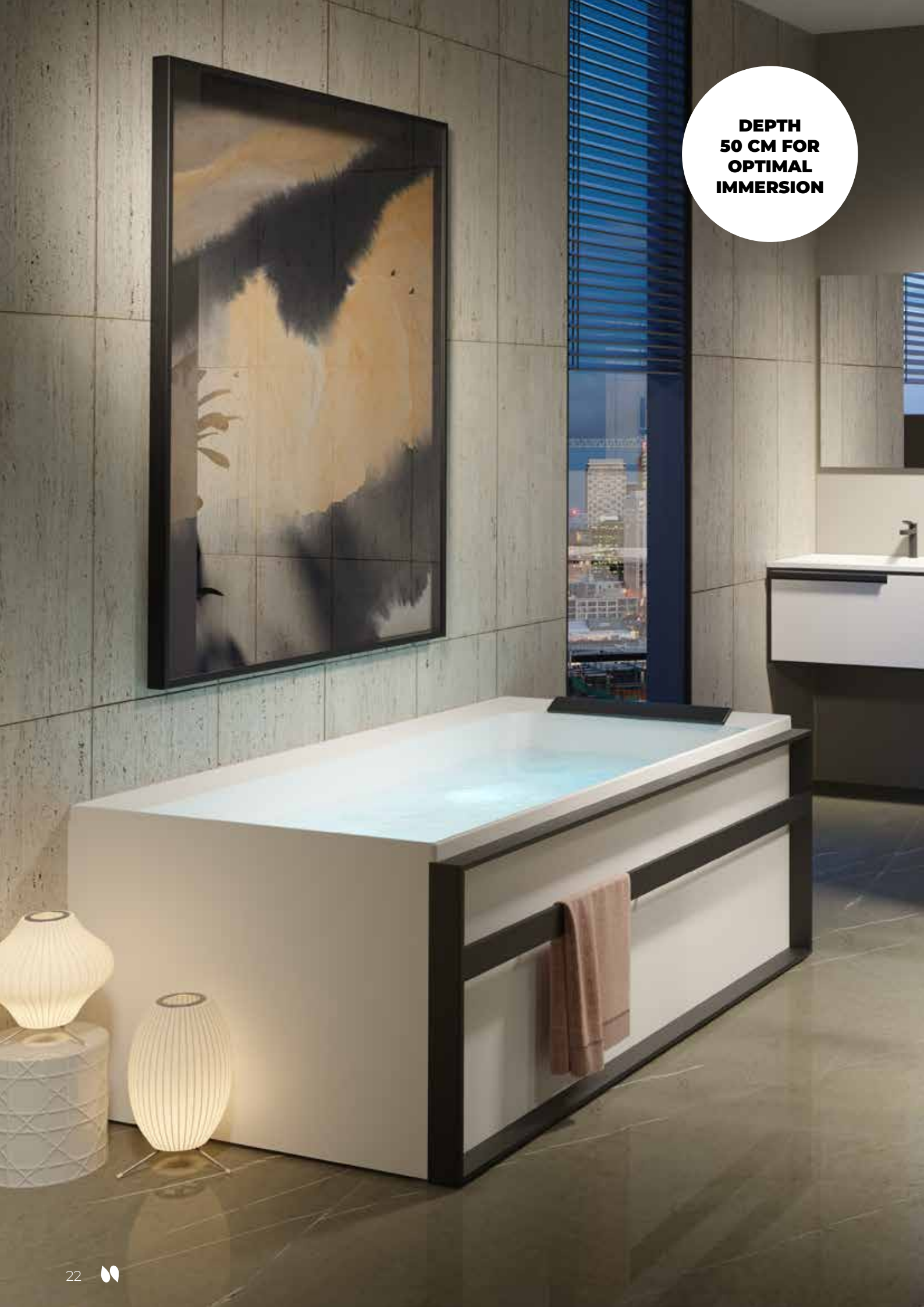



COLLECTION **DIVINA**

DESIGN AND PLEASURE

The Divina collection is the star of Novellini's bathtub range and is distinguished by its soft, elegant lines. The original design of these baths with bevelled edges is underlined by the quality and nobility of the materials.

Easy to use, they offer a range of water and air massages. A pleasure for the body and the eyes guaranteed!



Intuitive touch-sensitive keypad integrated in the edge of the bathtub. Simply press a button to activate the desired function.



The blade-shaped water jets ensure total body envelopment.

To better target the areas of the body that need to be stimulated, these jets can be oriented.

The jets are backlit in the Hydro Plus and Natural Air+Whirlpool versions.



The air injectors placed in the bottom of the bath are flush and almost invisible providing greater comfort to your bath.



All Divina bathtubs have a practical click-clack drain. The drain cover is finished to match the bathtub.

DIVINA 35

RECTANGULAR BATHTUB

Edge height 3,5 cm

VERSIONS

EQUIPMENT

TO BE INSTALLED WITH FEET

headrest
emptying clic-clac

WITH CHASSIS SELF-SERVING

headrest
emptying clic-clac

STANDARD SANS SYSTÈME BATH	AIRPOOL AIR SYSTEM HYDRO AIR	WHIRLPOOL WATER SYSTEM WHIRLPOOL	AIRPOOL + WHIRLPOOL MIXED SYSTEM HYDRO PLUS	NATURAL AIR MICRO-BUBBLE SYSTEM AIR NATURAL AIR	NATURAL AIR + WHIRLPOOL MICRO-BUBBLE AIR + WATER SYSTEM NATURAL AIR + WHIRLPOOL
•					
•	•	•	•	•	•



GLOSSY WHITE WHITE MAT

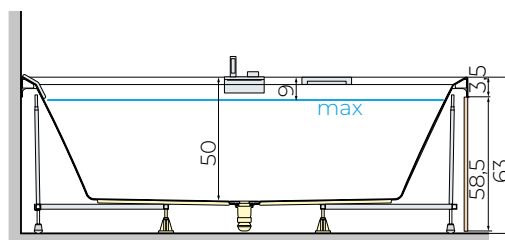
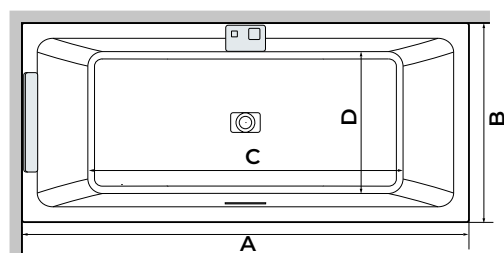

MODEL	A	B	C	D	CAPACITY
160x70	160 cm	70 cm	105 cm	46 cm	260 litres
170x70	170 cm	70 cm	115 cm	46 cm	280 litres
170x75	170 cm	75 cm	115 cm	51 cm	300 litres
180x80	180 cm	80 cm	125 cm	56 cm	350 litres
180x100	180 cm	100 cm	125 cm	76 cm	430 litres
190x90	190 cm	90 cm	135 cm	66 cm	420 litres

OPTIONS

Fittings, overflow filler, cup holders, see page 38-39

Can be complemented with YOUNG IV or YOUNG 1BSV bath screen, see page 39

Aprons for niche, corner, U-shaped wall or island installation

HPL APRONS, FINISHES :

WHITE to match the bathtub		CLAY			WOOD			
GLOSSY WHITE	WHITE MAT	PECE	TORTORA	POLVERE	WHITEWOOD	GRAIN	BURLINGTON	DOLOMITE

CAN BE COMBINED WITH :

–	BLACK FRAME	BLACK FRAME WHITE FRAME	BLACK FRAME WHITE FRAME	BLACK FRAME WHITE FRAME	BLACK FRAME WHITE FRAME	BLACK FRAME WHITE FRAME	BLACK FRAME WHITE FRAME	BLACK FRAME WHITE FRAME
---	-------------	----------------------------	----------------------------	----------------------------	----------------------------	----------------------------	----------------------------	----------------------------

Frame aprons are available with the MODEL Divina 35 only

DIVINA 35



DIVINA

RECTANGULAR BATHTUB

Edge height 3,5 cm

VERSIONS	EQUIPMENT	STANDARD SANS SYSTÈME BATH	AIRPOOL AIR SYSTEM HYDRO AIR	WHIRLPOOL WATER SYSTEM WHIRLPOOL	AIRPOOL + WHIRLPOOL MIXED SYSTEM HYDRO PLUS	NATURAL AIR MICRO-BUBBLE SYSTEM AIR NATURAL AIR	NATURAL AIR + WHIRLPOOL MICRO-BUBBLE AIR + WATER SYSTEM NATURAL AIR + WHIRLPOOL
TO BE INSTALLED WITH FEET	headrest emptying clic-clac	•					
WITH CHASSIS SELF-SERVING	headrest emptying clic-clac	•	•	•	•	•	•

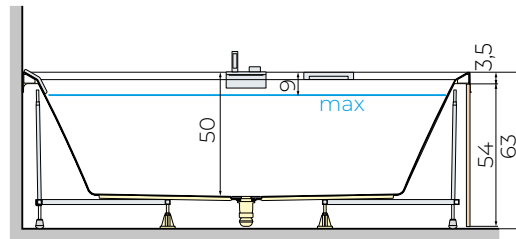
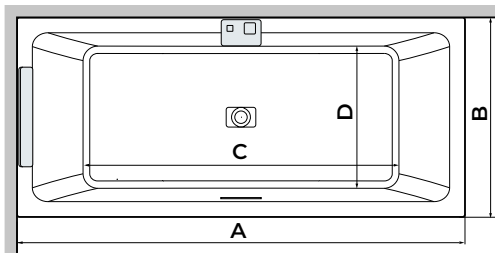

MODEL	A	B	C	D	CAPACITY
160x70	160 cm	70 cm	105 cm	46 cm	260 litres
170x70	170 cm	70 cm	115 cm	46 cm	280 litres
170x75	170 cm	75 cm	115 cm	51 cm	300 litres
180x80	180 cm	80 cm	125 cm	56 cm	350 litres
180x100	180 cm	100 cm	125 cm	76 cm	430 litres
190x90	190 cm	90 cm	135 cm	66 cm	420 litres

OPTIONS

Fittings, overflow filler, cup holders, see page 38-39

Can be complemented with YOUNG 1V or YOUNG 1BSV bath screen, see page 39

Aprons for niche, corner, U-shaped wall or island installation

HPL APRONS, FINISHES :



Frame aprons are not available with the MODEL Divina 8 cm edge

DIVINA



DIVINA O

ASYMMETRIC BATHTUB

Edge height 3,5 CM

VERSIONS	EQUIPMENT
TO BE INSTALLED WITH FEET	headrest emptying clic-clac
WITH CHASSIS SELF-SERVING	headrest emptying clic-clac

STANDARD SANS SYSTÈME BATH	AIRPOOL AIR SYSTEM HYDRO AIR	WHIRLPOOL WATER SYSTEM WHIRLPOOL	AIRPOOL + WHIRLPOOL MIXED SYSTEM HYDRO PLUS	NATURAL AIR MICRO-BUBBLE SYSTEM AIR NATURAL AIR	NATURAL AIR + WHIRLPOOL MICRO-BUBBLE AIR + WATER SYSTEM NATURAL AIR + WHIRLPOOL
•					
•	•	•	•	•	•

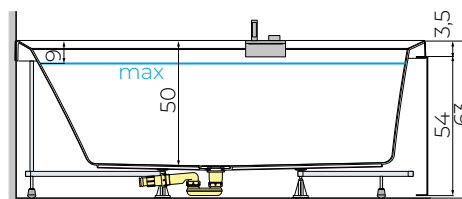
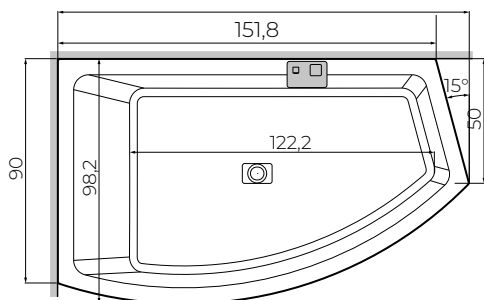
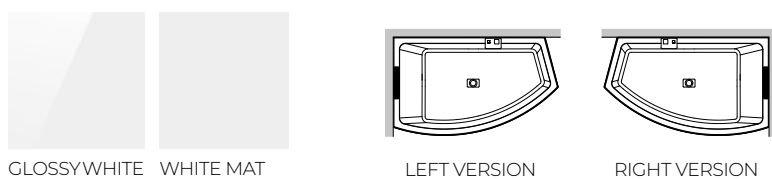

MODEL	CAPACITY
165x98 cm	360 litres

OPTIONS

Fittings, overflow filler, cup holders, see page 38-39
Apron for corner installation

HPL DECK, FINISHES :

WHITE to match the bathtub		CLAY			WOOD			
GLOSSY WHITE	WHITE MAT	PECE	TORTORA	POLVERE	WHITEWOOD	GRAIN	BURLINGTON	DOLOMITE

DIVINA O



DIVINA C

CORNER BATHTUB

Edge height 3,5 cm

VERSIONS	EQUIPMENT
TO BE INSTALLED WITH FEET	headrest emptying clic-clac
WITH CHASSIS SELF-SERVING	headrest emptying clic-clac

STANDARD SANS SYSTÈME BATH	AIRPOOL AIR SYSTEM HYDRO AIR	WHIRLPOOL WATER SYSTEM WHIRLPOOL	AIRPOOL + WHIRLPOOL MIXED SYSTEM HYDRO PLUS	NATURAL AIR MICRO-BUBBLE SYSTEM AIR NATURAL AIR	NATURAL AIR + WHIRLPOOL MICRO-BUBBLE AIR + WATER SYSTEM NATURAL AIR + WHIRLPOOL
•					
•	•	•	•	•	•

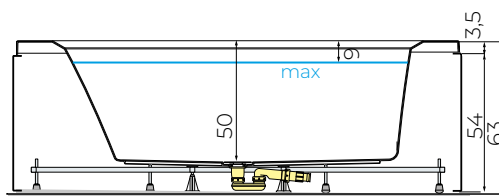
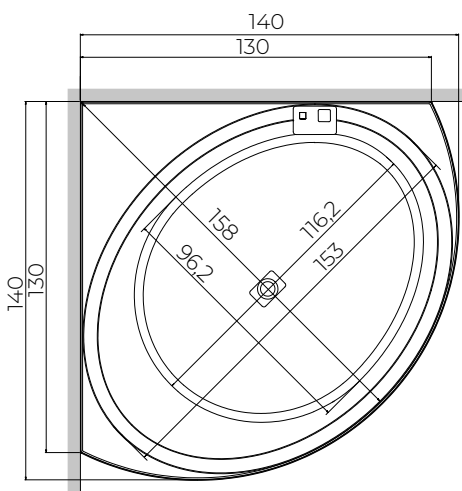

MODEL	CAPACITY
140x140 cm	400 litres

OPTIONS

Fittings, overflow filler, cup holders, see page 38-39
Apron for corner installation

HPL DECK, FINISHES :

WHITE
to match the bathtub



GLOSSY WHITE WHITE MAT

CLAY



PECE TORTORA POLVERE

WOOD



WHITEWOOD GRAIN BURLINGTON DOLOMITE

DIVINA C



DIVINA W

**BATH FOR WALL OR CORNER
INSTALLATION**
Edge height 3,5 cm

VERSIONS	EQUIPMENT
TO BE INSTALLED WITH FEET	headrest emptying clic-clac
WITH CHASSIS SELF-SERVING	headrest emptying clic-clac

STANDARD SANS SYSTÈME BATH	AIRPOOL AIR SYSTEM HYDRO AIR	WHIRLPOOL WATER SYSTEM WHIRLPOOL	AIRPOOL + WHIRLPOOL MIXED SYSTEM HYDRO PLUS	NATURAL AIR MICRO-BUBBLE SYSTEM AIR NATURAL AIR	NATURAL AIR + WHIRLPOOL MICRO-BUBBLE AIR + WATER SYSTEM NATURAL AIR + WHIRLPOOL
•					
•	•	•	•	•	•

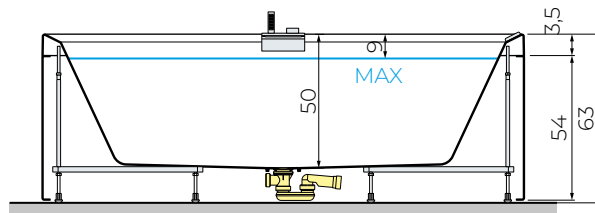
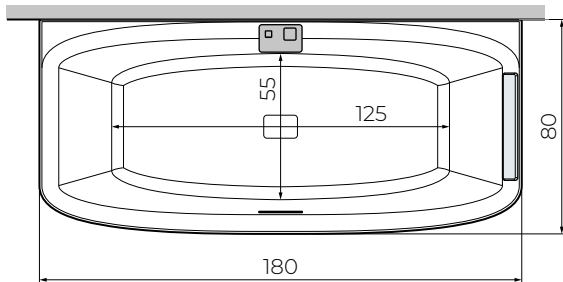

MODEL	CAPACITY
180x80 cm	320 litres

OPTIONS

Fittings, overflow filler, cup holders, see page 38-39
Aprons for corner or U-shaped wall installation.

HPL DECK, FINISHES :

WHITE to match the bathtub		CLAY			WOOD			
GLOSSY WHITE	WHITE MAT	CENERE	TORTORA	POLVERE	WHITWOOD	GRAIN	BURLINGTON	DOLOMITE

4 NATURAL CLAY COLOURS ON REQUEST

CLAY			
CIPRIA	TEGOLA	ALGA	SENAPE

DIVINA C



DIVINA F

FREESTANDING BATHTUB

Edge height 3,5 cm

VERSIONS	EQUIPMENT
TO BE INSTALLED WITH FEET	headrest emptying clic-clac
WITH CHASSIS SELF-SERVING	headrest emptying clic-clac full apron

STANDARD WITHOUT SYSTEM BATH	AIRPOOL AIR SYSTEM HYDRO AIR
•	
•	•



GLOSSYWHITE WHITE MAT

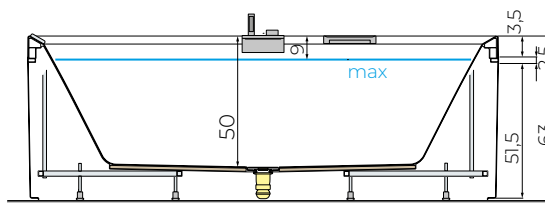
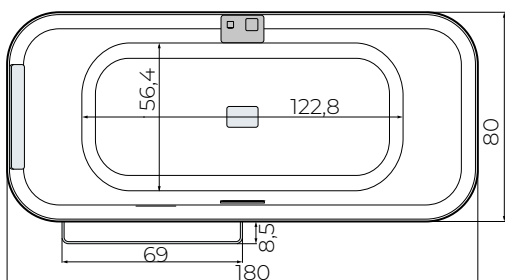

FULL THERMOFORMED APRON

For island installation

Standard with Divina F bathtubs with frame.

Finished to match the bathtub + metal belt with soap dish and towel rail

MODEL	CAPACITY
180x80 cm	400 litres

DIVINA F 35

FREESTANDING BATHTUB

Edge height 3,5 CM

VERSIONS	EQUIPMENT
TO BE INSTALLED WITH FEET	headrest emptying clic-clac

STANDARD WITHOUT SYSTEM BATH
•



OPTIONS FOR DIVINA F AND DIVINA F 35

Fittings, cupboard, see page .38-39

DIVINA F



MASSAGE SYSTEMS

AIRPOOL

HYDRO AIR

Air massage system
- 16 bottom air injectors
400 W



Continuous air massage or alternating

DIVINA AND DIVINA 35

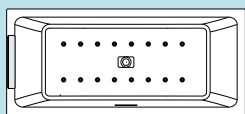

DIVINA O

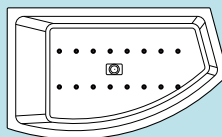

HYGIENE

AIR: Drying of air ducts at the end of the bath

DIVINA C

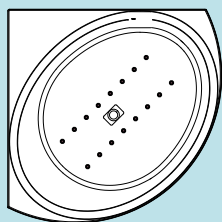

DIVINA F

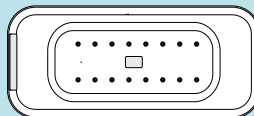

DIVINA W

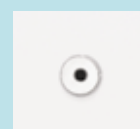
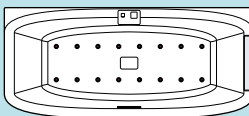

Air injector

WHIRLPOOL

WHIRLPOOL

Water massage system
- 6 side water jets
900 W



Water massage with variable intensity from strongest to weakest with the possibility to stop on an intensity

DIVINA AND DIVINA 35



DIVINA O

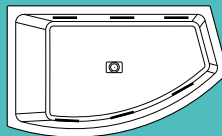

HYGIENE

WATER: Use products adapted to whirlpool baths to disinfect the water circuit: fill your bathtub, pour the product into the water and start the water massage.

DIVINA C

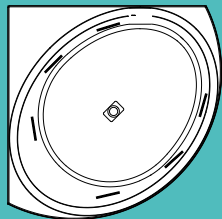

DIVINA W

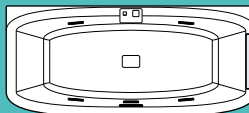

Adjustable water jet en forme de lame

AIRPOOL AND WHIRLPOOL

HYDRO PLUS

Mixed massage system
- 16 bottom air injectors
400 W
- 6 backlit side water jets
900 W



Continuous air massage or alternating



Water massage with variable intensity from strongest to weakest with the possibility to stop on an intensity



Chromolight: backlit jets with multicolour light diffusion with the possibility of stopping on a colour



Playback of music stored on a phone or tablet via Bluetooth connection

DIVINA AND DIVINA 35

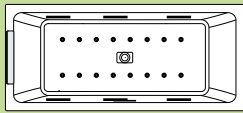

DIVINA O

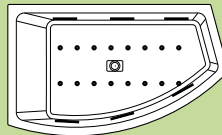

HYGIENE

AIR: Drying of air ducts at the end of the bath

WATER: Use products adapted to whirlpool baths to disinfect the water circuit: fill your bathtub, pour the product into the water and start the water massage.

DIVINA C

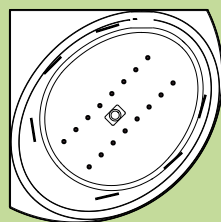

DIVINA W

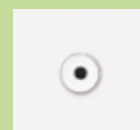
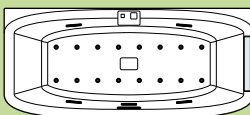

Air injector



Water jets backlit, adjustable blade-shaped



NATURAL AIR

NATURAL AIR

Micro air bubble massage system
- 1 Natural Air Diffuser
1 050 W

 Diffusion of micro air bubbles in the bath water On/off operation

DIVINA AND DIVINA 35



DIVINA O

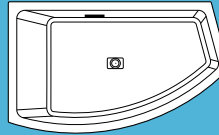

DIVINA C

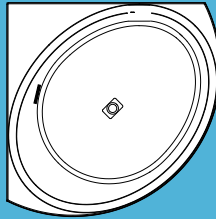

DIVINA W

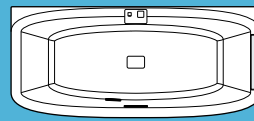



Natural Air Diffuser backlit Led WHITE

NATURAL AIR AND WHIRLPOOL

NATURAL AIR + WHIRLPOOL

Water massage system with air micro-bubble diffusion
- 6 backlit water jets on the sides
900 W
- 1 Natural Air Diffuser
1 050 W

 Diffusion of micro air bubbles in the bath water On/off operation

 Water massage with variable intensity from strongest to weakest with the possibility to stop on an intensity

 Chromolight: backlit jets with multicolour light diffusion with the possibility of stopping on a colour

 Playback of music stored on a phone or tablet via Bluetooth connection

DIVINA AND DIVINA 35

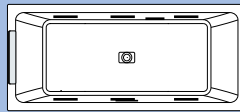

DIVINA O

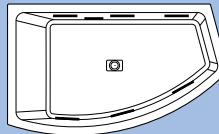

DIVINA C

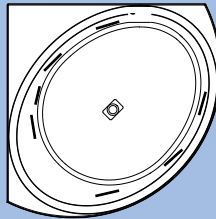

DIVINA W

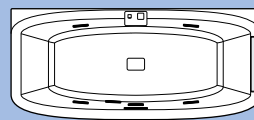

HYGIENE

WATER: Use products adapted to whirlpool baths to disinfect the water circuit: fill your bathtub, pour the product into the water and start the water massage.



Natural Air Diffuser



Water jets backlit, adjustable blade-shaped



WATER JETS WHIRLPOOL



WATER JETS BACKLIT HYDRO PLUS and NATURAL AIR+WHIRLPOOL



AIR INJECTORS HYDRO AIR



MICRO-BUBBLE AIR DIFFUSER NATURAL AIR and NATURAL AIR+WHIRLPOOL



MUSIQUE BLUETOOTH
playback of music stored on external devices through the bathtub walls
HYDRO PLUS
and **NATURAL AIR+WHIRLPOOL**

OPTIONS



BATHTUB EDGE FITTINGS

Constant flow, variable temperature
- waterfall filling spout
- hand shower with anti-drip hose
Finishes: chrome or black



OVERFLOW FILLING

This system combines the filling and overflow functions and replaces the classic spout to provide you with a more comfortable experience.



OBJECT SHELF

Shelf to be fixed to the edge of the bathtub. Its internal structure makes it exceptionally strong and the polyurethane coating makes it pleasant to use.

Suitable for all bathtubs in the DIVINA collection.



OBJECT HOLDER TRAY

The tray can be placed in any position you wish. Its solid construction makes it particularly stable. Suitable for DIVINA 35, DIVINA and DIVINA F baths.



BATH SCREENS

The DIVINA 35 and DIVINA rectangular bathtubs this bath is perfectly suitable for any bath screen, can be complemented with bath screens from the Novellini range:

YOUNG TV : bath screen with 1 pivoting flap

YOUNG 1 BSV: 1-panel bath screen, pivoting and folding

6 mm thick glass. WHITE, Silver, Chrome or Matt Black profiles. An adaptation kit is required for installation



KIT HYDROSILENCE

The turbines and pumps in our baths are soundproofed so you can enjoy your massage. The Hydrosilence kit further reduces noise and vibration to make your whirlpool sessions even quieter.

DIVINA DUAL

TWO SEATER BATHTUB SIDE BY SIDE

VERSIONS

EQUIPMENT

WITH CHASSIS
SELF-SERVING

2 headrests
seat

STANDARD WITHOUT SYSTEM BATH	WHIRLPOOL WATER SYSTEM WHIRLPOOL	WHIRLPOOL WATER SYSTEM WHIRLPOOL WITH CASCADE	AIRPOOL + WHIRLPOOL MIXED SYSTEM WHIRLPOOL + AIRPOOL	NATURAL AIR + WHIRLPOOL MICRO-BUBBLE AIR + WATER SYSTEM	NATURAL AIR + WHIRLPOOL MICRO-BUBBLE AIR + WATER SYSTEM	NATURAL AIR + WHIRLPOOL WITH CASCADE
•	•	•	•	•	•	•

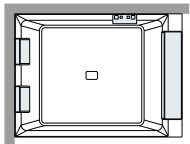
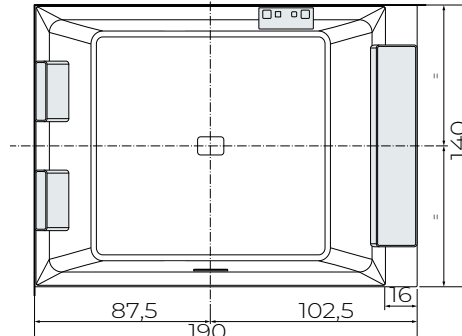

LEFT VERSION

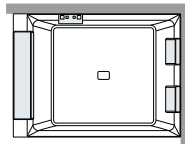

RIGHT VERSION

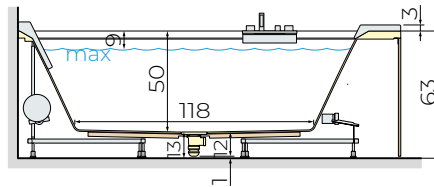

INSTALLATION POSSIBILITIES :

- NICHE with 1 front panel
- ANGLE with 1 front and 1 side panel
- U-shaped with 1 front and 2 side curtains
- ISLAND with 2 front and 2 side curtains



BATHTUB EDGE FITTINGS WITH CONSTANT FLOW

- waterfall filling spout
- hand shower with anti-drip hose
- temperature control
- diverter
- Finishes: chrome or black

MODEL	CAPACITY
190x140 cm	650 litres

TABLIERS



TABLIER WHITE OU
FINITION WOOD OU CLAY



APRON WITH A FRAME
WHITE ALUMINIUM FRAME



APRON WITH A FRAME
BLACK ALUMINIUM FRAME

HPL APRONS, FINISHES :

WHITE to match the bathtub		CLAY			WOOD			
GLOSSY WHITE	WHITE MAT	PECE	TORTORA	POLVERE	WHITEWOOD	GRAIN	BURLINGTON	DOLOMITE

CAN BE COMBINED WITH :

- BLACK FRAME
- BLACK FRAME WHITE FRAME
- BLACK FRAME WHITE FRAME
- BLACK FRAME WHITE FRAME
- BLACK FRAME WHITE FRAME
- BLACK FRAME WHITE FRAME
- BLACK FRAME WHITE FRAME
- BLACK FRAME WHITE FRAME

DIVINA DUAL



MASSAGE SYSTEMS

WHIRLPOOL

WHIRLPOOL

Système de massage Eau
 • 8 buses d'eau latérales
 900 W + 900 W



Water On/Off Massage

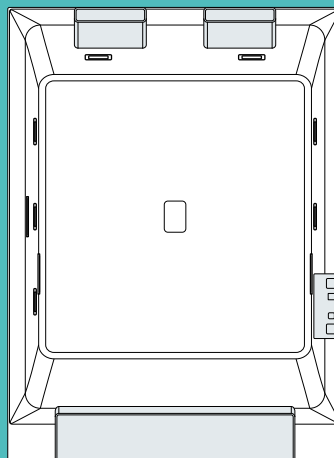

HYGIENE

WATER: Use products adapted to whirlpool baths to disinfect the water circuit: fill your bathtub, pour the product into the water and start the water massage.



Adjustable water jet en forme de lame

WHIRLPOOL

WHIRLPOOL WITH CASCADE

Water massage system
 - 8 side water jets
 900 W + 900 W
 - Waterfall water blade LED lighting
 550 W



Water massage with variable intensity from strongest to weakest with the possibility of stopping on an intensity



Water cascade, closed circuit operation



Chromolight: backlit jets with multicolour light diffusion with the possibility of stopping on a colour



Playback of music stored on a phone or tablet via Bluetooth connection



Disinfection programme

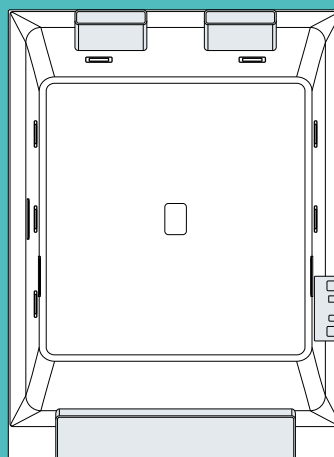

HYGIENE

EAU : Disinfection programme des conduits Eau. Utilisez les produits adaptés aux BATHs BATH. Versez le produit dans le réservoir prévu à cet effet et lancez le Disinfection programme.



Adjustable water jet en forme de lame

AIRPOOL AND WHIRLPOOL

WHIRLPOOL + AIRPOOL

Water massage system
 - 8 side water jets
 900 W + 900 W
 - Waterfall water blade LED lighting
 550 W



Continuous or alternating air massage



Water massage with variable intensity from strongest to weakest with the possibility of stopping on an intensity



Chromolight: backlit jets with multicolour light diffusion with the possibility of stopping on a colour



Playback of music stored on a phone or tablet via Bluetooth connection



Disinfection programme

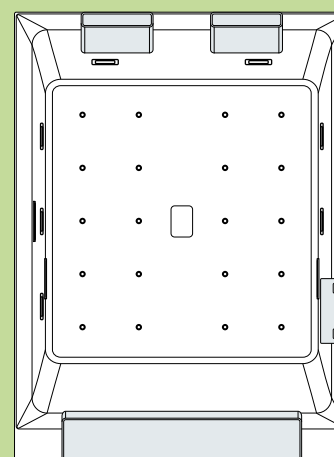

HYGIENE

AIR: Drying of air ducts at the end of the bath

EAU : Disinfection programme des conduits Eau. Utilisez les produits adaptés aux BATHs BATH. Versez le produit dans le réservoir prévu à cet effet et lancez le Disinfection programme.

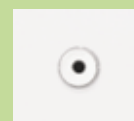

Air injector









Adjustable water jet en forme de lame

NATURAL AIR AND WHIRLPOOL

WHIRLPOOL + NATURAL AIR

Water massage system with air micro-bubble diffusion
 - 8 lateral water jets 900 W + 900 W
 - 2 Natural Air diffusers 1 050 W

-  Natural Air : diffusion de micro-bulles d'air dans l'eau du bain Fonctionnement en mode marche/ arrêt
-  Water massage with variable intensity from strongest to weakest with the possibility of stopping on an intensity
-  Chromolight: backlit jets with multicolour light diffusion with the possibility of stopping on a colour
-  Playback of music stored on a phone or tablet via Bluetooth connection
-  Water heater : maintaining the bath water temperature
-  Disinfection programme

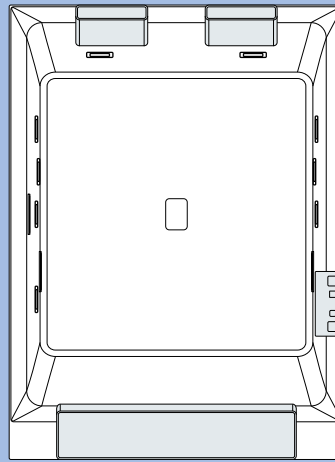

HYGIENE

EAU : Disinfection programme des conduits Eau. Utilisez les produits adaptés aux BATHs BATH. Versez le produit dans le réservoir prévu à cet effet et lancez le Disinfection programme.



Natural Air Diffuser









Adjustable water jet en forme de lame

NATURAL AIR AND WHIRLPOOL

WHIRLPOOL + NATURAL AIR WITH CASCADE

Water massage system with air micro-bubble diffusion
 - 8 lateral water jets 900 W + 900 W
 - 2 Natural Air diffusers 1050 W
 - Waterfall water blade LED lighting 550 W

-  Natural Air : diffusion de micro-bulles d'air dans l'eau du bain Fonctionnement en mode marche/ arrêt
-  Water massage with variable intensity from strongest to weakest with the possibility of stopping on an intensity
-  Water cascade, closed circuit operation
-  Chromolight: backlit jets with multicolour light diffusion with the possibility of stopping on a colour
-  Playback of music stored on a phone or tablet via Bluetooth connection
-  Water heater : maintaining the bath water temperature
-  Disinfection programme

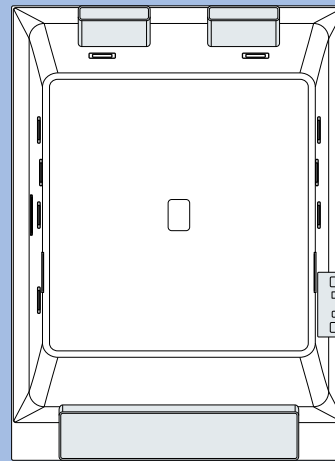

HYGIENE

EAU : Disinfection programme des conduits Eau. Utilisez les produits adaptés aux BATHs BATH. Versez le produit dans le réservoir prévu à cet effet et lancez le programme de Disinfection.



Natural Air Diffuser



Adjustable water jet en forme de lame



WATER JETS WHIRLPOOL



BACKLIT WATER JETS - WHIRLPOOL WITH CASCADE - WHIRLPOOL+AIRPOOL - NATURAL AIR+WHIRLPOOL - NATURAL AIR+WHIRLPOOL WITH CASCADE



AIR INJECTORS WHIRLPOOL+AIRPOOL



MICRO-BUBBLE AIR DIFFUSER - NATURAL AIR+WHIRLPOOL - NATURAL AIR+WHIRLPOOL WITH CASCADE



MUSIC BLUETOOTH
 diffusion of music stored on external devices through the walls of the bath.
 - WHIRLPOOL WITH CASCADE
 - WHIRLPOOL+AIRPOOL
 - NATURAL AIR+WHIRLPOOL
 - NATURAL AIR+WHIRLPOOL WITH CASCADE



CASCADE BACKLIT WATER BLADE- WHIRLPOOL WITH CASCADE - NATURAL AIR+WHIRLPOOL WITH CASCADE



TEMPERATURE STABILISER HEATER
 temperature of the bath water at its initial level when the massage is on
 Water is on
 - NATURAL AIR+WHIRLPOOL
 - NATURAL AIR+WHIRLPOOL WITH CASCADE



COLLECTION **SENSE 2.0**

VARIETY OF JETS AND FULL BODY MASSAGES

The Sense 2.0 collection has been designed to offer you perfect comfort and a timeless aesthetic.

The placement of the jets has been designed to act on the sensitive areas of your body and provide maximum relaxation. The combination of air and water massages will meet your expectations in terms of relaxation and vitality.



The chrome-plated water JETS can be turned in different directions and can be used to target the areas of the body that need to be stimulated. The inside of the JETS and their outline are backlit in the Whirlpool+Disinfection+Light, Hydro Plus and Natural Air +Whirlpool versions.

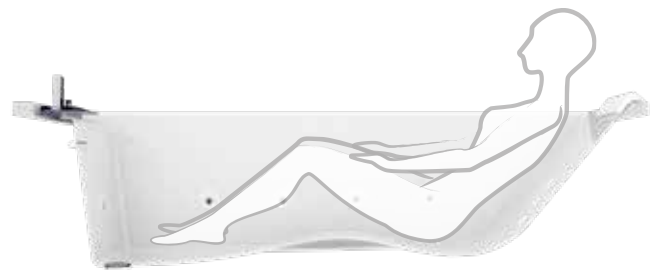

The jets are positioned to stimulate the reflex zones of your body, with particular attention to the back and plantar zones. In addition, the MODEL Sense 3 2.0 has the morphological chair-length base that allows the body to adopt the best position for an effective massage.



The ergonomic control panel provides easy access to all functions of your bathtub. Its finish matches that of the bathtub. A simple touch is all it takes to access your favourite massages.

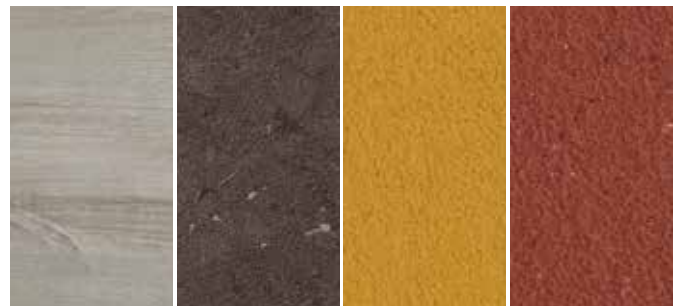

In terms of design, the Sense 2.0 line offers aprons in HPL WHITES or in natural finishes: WOOD or CLAY.

SENSE 3 2.0

RECTANGULAR BATHTUB Ergonomic lounger at the bottom



VERSIONS

EQUIPMENT

TO BE INSTALLED WITH FEET

WITH CHASSIS SELF-SERVING

headrest emptying automatic

STANDARD WITHOUT SYSTEM BATH	AIRPOOL AIR SYSTEM HYDRO AIR	WHIRLPOOL WATER SYSTEM WHIRLPOOL + DISINFECTION	WHIRLPOOL WATER SYSTEM WHIRLPOOL + DISINFECTION + LIGHT	AIRPOOL + WHIRLPOOL MIXED SYSTEM HYDRO PLUS	NATURAL AIR + WHIRLPOOL MICRO-BUBBLE AIR + WATER SYSTEM NATURAL AIR + WHIRLPOOL
•					
•	•	•	•	•	•

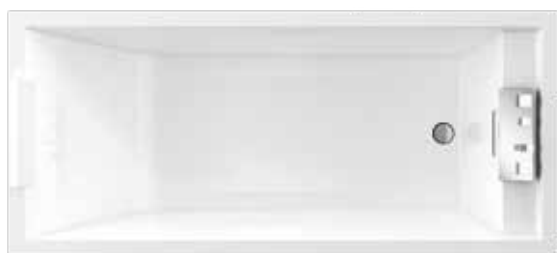

GLOSSYWHITE WHITE MAT

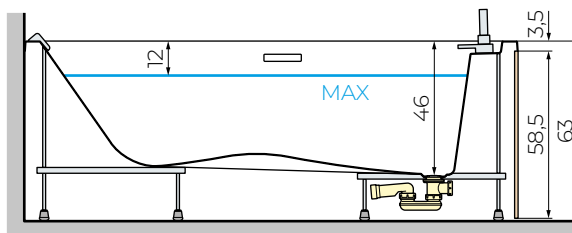
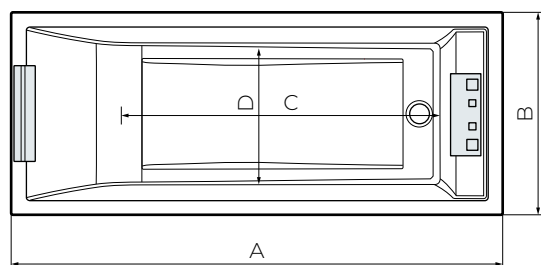

MODEL	A	B	C	D	CAPACITY
170x70	170 cm	70 cm	110,7 cm	47,5 cm	205 litres
170x75	170 cm	75 cm	110,7 cm	52,5 cm	225 litres
180x80	180 cm	80 cm	114,2 cm	57,5 cm	250 litres
190x80	190 cm	80 cm	117,3 cm	57,5 cm	265 litres

OPTIONS



- BATHTUB EDGE FITTINGS WITH CONSTANT FLOW
- waterfall filling spout
 - hand shower with anti-drip hose
 - temperature control
 - diverter
 - Finish: chrome

TABLIERS

For installation in a niche, corner, U-shaped wall or island

HPL APRONS, FINISHES :

WHITE to match the bathtub		CLAY			WOOD			
GLOSSY WHITE	WHITE MAT	CENERE	TORTORA	POLVERE	WHITEWOOD	GRAIN	BURLINGTON	DOLOMITE

4 NATURAL CLAY COLOURS ON REQUEST

CLAY			
CIPRIA	TEGOLA	ALGA	SENAPE

SENSE 3 2.0



SENSE 4 2.0

RECTANGULAR BATHTUB

Flat bottom



VERSIONS

EQUIPMENT

TO BE INSTALLED WITH FEET

WITH CHASSIS SELF-SERVING

headrest emptying automatic

	STANDARD WITHOUT SYSTEM BATH	AIRPOOL AIR SYSTEM HYDRO AIR	WHIRLPOOL WATER SYSTEM WHIRLPOOL + DISINFECTION	WHIRLPOOL WATER SYSTEM WHIRLPOOL + DISINFECTION + LIGHT	AIRPOOL + WHIRLPOOL MIXED SYSTEM HYDRO PLUS	NATURAL AIR + WHIRLPOOL MICRO-BUBBLE AIR + WATER SYSTEM
TO BE INSTALLED WITH FEET	•					
WITH CHASSIS SELF-SERVING	•	•	•	•	•	•



GLOSSYWHITE WHITE MAT

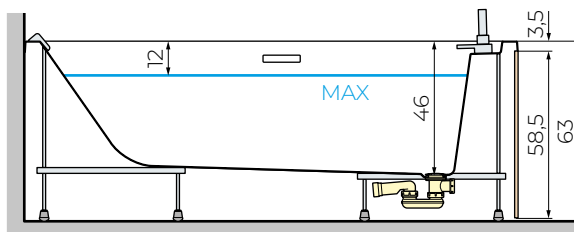
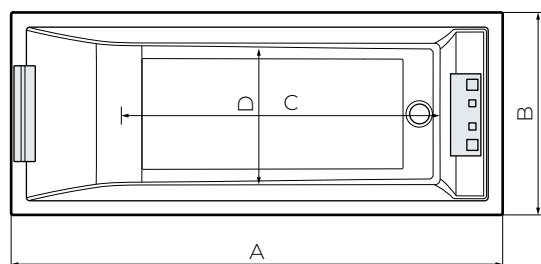

MODEL	A	B	C	D	CAPACITY
170x70	170 cm	70 cm	110,7 cm	47,5 cm	205 litres
170x75	170 cm	75 cm	110,7 cm	52,5 cm	225 litres
180x80	180 cm	80 cm	114,2 cm	57,5 cm	250 litres
190x80	190 cm	80 cm	117,3 cm	57,5 cm	265 litres

OPTIONS



BATHTUB EDGE FITTINGS WITH CONSTANT FLOW

- waterfall filling spout
- hand shower with anti-drip hose
- temperature control
- diverter
- Finish: chrome

TABLIERS

For installation in a niche, corner, U-shaped wall or island

HPL APRONS, FINISHES :

WHITE to match the bathtub		CLAY			WOOD			
GLOSSY WHITE	WHITE MAT	CENERE	TORTORA	POLVERE	WHITEWOOD	GRAIN	BURLINGTON	DOLOMITE

4 NATURAL CLAY COLOURS ON REQUEST

CLAY			
CIPRIA	TEGOLA	ALGA	SENAPE

SENSE 4 2.0



MASSAGE SYSTEMS

AIRPOOL

HYDRO AIR

Air massage system
- 10 bottom air injectors
+ 6 back air injectors
400 W



Continuous or alternating air massage



Chromolight: light sequence programmes with the possibility of stopping on a colour (spot)



Playback of music stored on a phone or tablet via Bluetooth connection

SENSE 3 ET 4 2.0

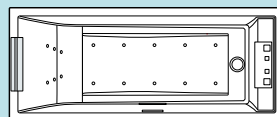

HYGIENE

AIR: Drying of air ducts at the end of the bath



Air injector à 5 sorties

WHIRLPOOL

WHIRLPOOL + Disinfection

Water massage system
- 6 side water jets
+ 2 water jets on the foot
550 W



Water massage, possibility to adjust the intensity of the massage for each jet



Disinfection programme

SENSE 3 ET 4 2.0

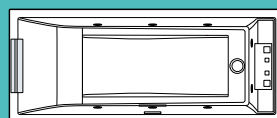

HYGIENE

WATER: Disinfection programme for water pipes. Use products suitable for whirlpool baths to fill the reservoir provided for this purpose.



Adjustable water jet

WHIRLPOOL

WHIRLPOOL + Disinfection + LIGHT

Système de massage Eau
• 6 buses d'eau latérales
+ 2 buses d'eau plantaires
550 W



Water massage, possibility to adjust the intensity of the massage for each jet



Chromolight: backlit jets with multicolour light diffusion with the possibility of stopping on a colour



Playback of music stored on a phone or tablet via Bluetooth connection



Disinfection programme

SENSE 3 ET 4 2.0

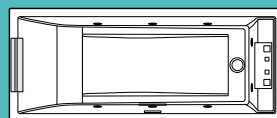

HYGIENE

WATER: Disinfection programme for water pipes. Use products suitable for whirlpool baths to fill the reservoir provided for this purpose.









Adjustable water jet

AIRPOOL AND WHIRLPOOL

HYDRO PLUS

Mixed massage system
 - 10 air injectors at the bottom 400 W
 - 8 side water jets
 + 2 plantar water jets
 + 6 micro water jets on the back
 900 W

-  Continuous or alternating air massage
-  Water massage, possibility to adjust the intensity of the massage for each jet
-  Chromolight : buses rétroéclairées avec diffusion de lumières multicolores avec possibilité de s'arrêter sur une couleur
-  Playback of music stored on a phone or tablet or tablet via Bluetooth connection
-  Water heater : maintaining the bath water temperature
-  Disinfection programme

SENSE 3 ET 4 2.0

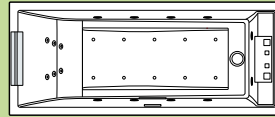

HYGIENE

AIR: Drying of air ducts at the end of the bath

WATER: Disinfection programme for pipes Water. Use products suitable for whirlpool baths to fill the reservoir provided for this purpose.



Air injector à 5 sorties







Adjustable water jet

NATURAL AIR AND WHIRLPOOL

NATURAL AIR + WHIRLPOOL

Water massage system with air micro-bubble diffusion
 - 6 side water jets 550 W
 - 1 Natural Air Diffuser
 1 050 W

-  Diffusion of micro air bubbles in the bath water On/off operation
-  Water massage, possibility to adjust the massage intensity for each JET
-  Chromolight: backlit jets with multicolour light diffusion with the possibility of stopping on a colour
-  Playback of music stored on a phone or tablet via Bluetooth connection

SENSE 3 ET 4 2.0

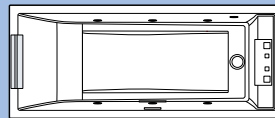

HYGIENE

WATER: Use products adapted to whirlpool baths to disinfect the water circuit: fill your bathtub, pour the product into the water and start the water massage.



Natural Air Diffuser



Adjustable water jet



MUSIC BLUETOOTH

diffusion of music stored on external devices through the walls of the bath.



BACKLIT JETS

light sequences to liven up your whirlpool sessions (except for Whirlpool+Disinfection system)



TEMPERATURE STABILISER HEATER

Maintains the bath water temperature at its initial level when the water massage is on

Available with the Hydro Plus system



COLLECTION **SENSE DUAL**

TWO-SEATER BATHTUB FACING EACH OTHER

This generously shaped bathtub has 2 seats facing each other. Thanks to its design and its outstanding finish, it will offer you an exceptional setting to enjoy effective massages with revitalising properties.



The ergonomic control panel provides easy access to all functions of your bathtub. Its finish matches that of the bathtub. A simple touch is all it takes to access your favourite massages.



The jets in the Sense Dual bath are powered by 2 pumps to provide effective massages.



To make you experience exceptional moments of relaxation, we have equipped the Sense Dual with a luminous LED line, the colour sequences will immerse you in relaxing or dynamic atmospheres.



The Sense Dual bathtub has speakers under its headrests so you can enjoy music via Bluetooth connection or listen to your favourite radio stations.

SENSE DUAL DOUBLE BATHTUB

VERSIONS

WITH CHASSIS
SELF-SERVING

EQUIPMENT

2 headrests
automatic emptying

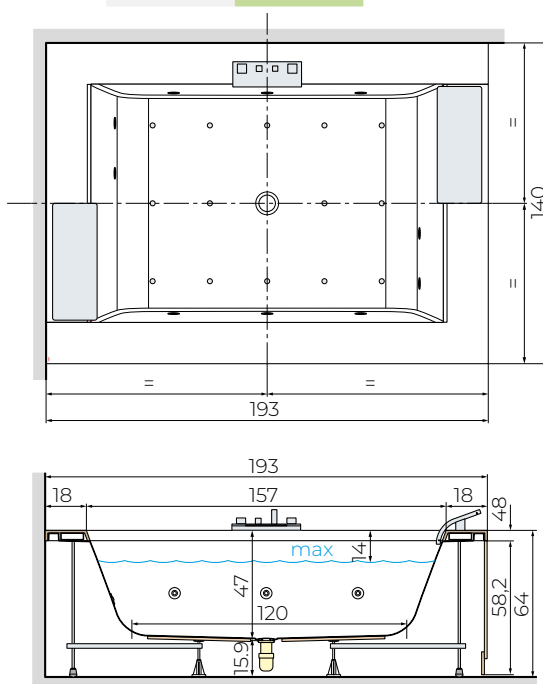

MODEL	CAPACITY
193x140 cm	450 litres

OPTIONS



- CONSTANT FLOW BATH EDGE FITTINGS
- waterfall filling spout
 - hand shower with anti-drip hose
 - temperature control
 - diverter
 - Chrome finish

APRONS AND BATHTUB RIMS

Aprons available for niche, corner, U-shaped wall or island installation

Different combinations of bathtub rim finish and aprons are possible

HPL APRONS, FINISHES :

WHITE
to match the bathtub



GLOSSY WHITE WHITE MAT

WOOD



WHITEWOOD GRAIN BURLINGTON DOLOMITE

SENSE DUAL









BATH **SENSE DUAL**

MASSAGE SYSTEM

AIRPOOL AND WHIRLPOOL

HYDRO PLUS

Mixed massage system
- 14 air injectors at the bottom
400 W
- 6 adjustable side water jets
+ 4 adjustable foot water jets
550 W + 550 W

-  Continuous or alternating air massage
-  Water massage with variable intensity from strongest to weakest with the possibility to stop on an intensity
-  Chromolight: light sequence programmes with the possibility of stopping on a colour
-  Playback of music stored on a phone or tablet via Bluetooth connection
-  RDS radio: transmission of FM channels
-  Water heater : maintaining the bath water temperature
-  Disinfection programme

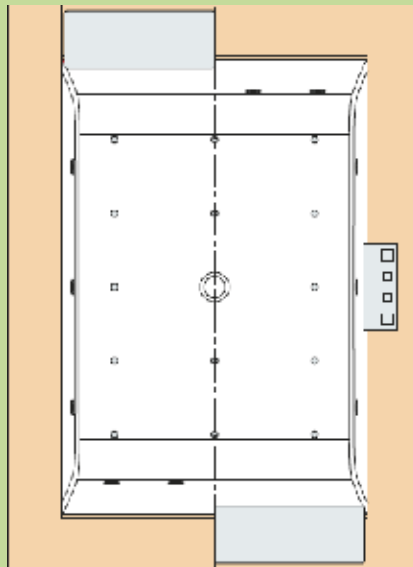

HYGIENE

AIR: Drying of air ducts at the end of the bath

EAU : Disinfection programme des conduits Eau. Utilisez les produits adaptés aux BATHs BATH pour remplir le réservoir prévu à cet effet



Air injector plat

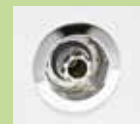

Adjustable water jet



MUSIC BLUETOOTH AND RADIO RDS

music and FM radio channels through the speakers under the bathtub cushion



MULTICOLOUR LED LIGHT

LED lights to liven up your BATH sessions



TEMPERATURE STABILISER HEATER

maintaining the temperature of the bath water at its initial level when the water massage is on





BURRO OPTIMUS
POLENGHI LOMBARDO



LA MIGLIORE QUALITÀ DI BURRO



COLLECTION **CLASSIC**

INTRODUCTION TO BATH MASSAGES

The Classic collection is the perfect step towards discovering the pleasures of whirlpooling.

This affordable collection offers a selection of baths with traditional shapes and essential massages. You'll appreciate the simple operation and a choice of baths that will fit easily into contemporary and classic settings.



The electronic keyboard with its sober design makes it easy to control the massages.



The massage systems in the Classic collection are perfect for anyone who wants to enjoy a whirlpool experience. a BATH experience. The essential and affordable massages.



The classic design of these MODELS allows them to be easily integrated into any environment. They benefit from the quality materials and all our know-how in terms of design and well-being.



The ergonomic and hygienic headrests of the Classic collection offer exceptional comfort (not available with built-in baths).

CALOS 2.0

RECTANGULAR BATHTUB

VERSIONS

EQUIPMENT

TO BE INSTALLED WITH FEET

WITH CHASSIS SELF-SERVING

headrest emptying automatic

	STANDARD WITHOUT SYSTEM BATH	WHIRLPOOL WATER SYSTEM HYDRO	WATER SYSTEM HYDRO + DISINFECTION	AIRPOOL + WHIRLPOOL MIXED SYSTEM HYDRO PLUS
TO BE INSTALLED WITH FEET	•			
WITH CHASSIS SELF-SERVING	•	•	•	•

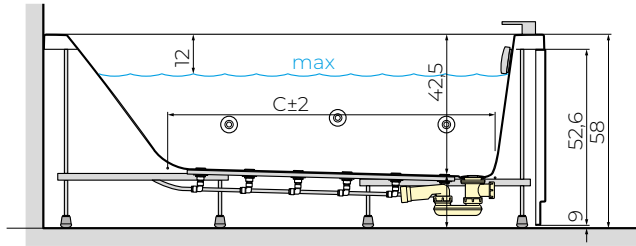
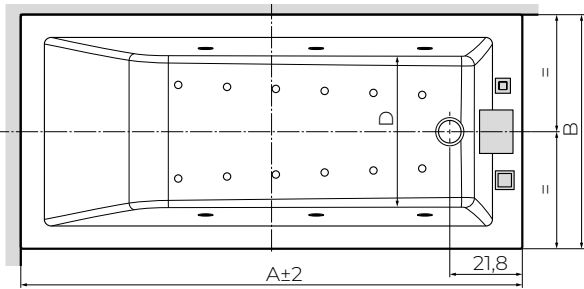
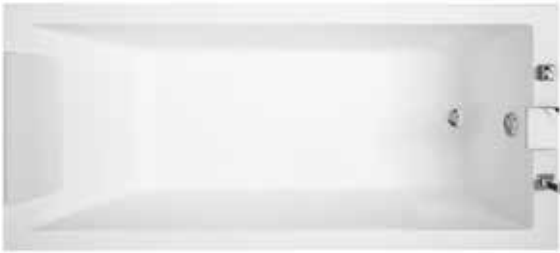

MODEL	A	B	C	D	CAPACITY
150x70	150 cm	70 cm	97,9 cm	44,4 cm	150 litres
160x70	160 cm	70 cm	108,1 cm	44,4 cm	160 litres
170x70	170 cm	70 cm	118,3 cm	44,4 cm	170 litres
170x75	170 cm	75 cm	118,3 cm	49,4 cm	180 litres
170x80	170 cm	80 cm	118,3 cm	54,4 cm	190 litres
180x80	180 cm	80 cm	128,5 cm	54,4 cm	200 litres

OPTIONS



FITTINGS
BATHTUB RIM
CONSTANT FLOW
 - waterfall filling spout
 - hand shower
 - temperature control
 - diverter



FILLING BY OVERFILLING
 The bathtub is filled through the hand wheel

TABLIERS

For installation in a niche, corner or U-shaped wall

HPL APRONS, FINISHES :

WHITE
to match the bathtub



Glossy white White mat

CLAY



PECE TORTORA POLVERE

WOOD



WHITEWOOD GRAIN BURLINGTON DOLOMITE

CALOS 2.0





COLLECTION **COMFORT**

ALL-IN-ONE BATH AND SHOWER

No longer is it necessary to choose between the convenience of a shower and the comfort of a bath. The elegant and stylish Iris walk-in bathtub will please the whole family.

It is also an ideal solution for smaller bathrooms. You will be charmed by its perfect finish and the choice of designer aprons.

The massages available with the Iris bathtub will awaken your senses in all simplicity.



The electronic keyboard with its sober design makes it easy to control the massages.



The massage systems of the Comfort Collection offer essential massages with simple operation.



Thanks to its 8 mm safety glass door, the Iris bathtub offers easy access. Complete with a bath screen, it also offers a practical shower area.



Every detail has been designed to provide you with maximum comfort. The fittings are located on the outer edge of the bathtub and are easily accessible. And the headrest of the Iris bathtub can easily be transformed into a seat.

IRIS

FAMILY BATH WITH DOOR

STANDARD WITHOUT SYSTEM BATH	WHIRLPOOL WATER SYSTEM HYDRO + DISINFECTION	AIRPOOL + WHIRLPOOL MIXED SYSTEM HYDRO PLUS
•	•	•

VERSIONS

**WITH CHASSIS
SELF-SERVING**

EQUIPMENT

headrest
emptying automatic



Glossy white

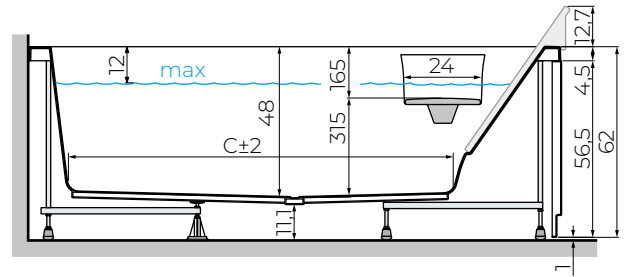
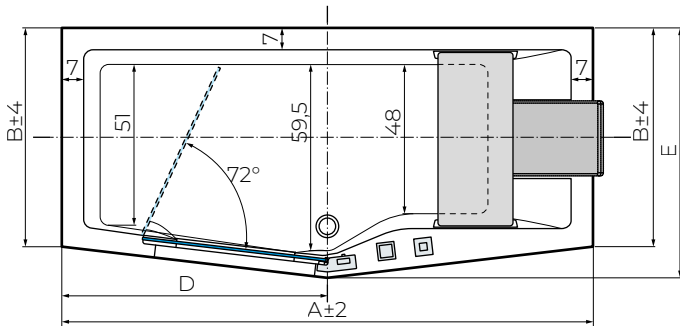

MODEL	A	B	C	D	E	CAPACITY
160x70/80	160 cm	70 cm	114 cm	86 cm	80 cm	250 litres
170x70/80	170 cm	70 cm	123,5 cm	85 cm	80 cm	265 litres
180x75/80	180 cm	75 cm	134,5 cm	86 cm	85 cm	305 litres

OPTIONS



FITTINGS
BATHTUB RIM
CONSTANT FLOW
- shower head
- temperature control
- overflow filling



FILLING BY OVERFILL
The bathtub is filled via the hand wheel



BATH SCREEN
6 mm clear safety glass with water-repellent treatment
Profile: Chrome
Iris Comby :
for corner installation
Iris Comby 2 :
for U-shaped installation



HEAD REST
For installation in a niche.
Cannot be used as a seat
Dimensions: 56 x 24 cm
Replaces the headrest supplied as standard with the bath.

TABLIERS

For installation in a niche, in a corner or in a U-shape against a wall

HPL APRONS, FINISHES :

WHITE
to match the bathtub



GLOSSY WHITE

WOOD



WHITE WOOD



GRAIN



BURLINGTON



DOLOMITE



WHIRLPOOL

HYDRO

Water massage system
 - 6 adjustable side water jets
 550 W (7 jets for the MODEL Vogue)

 Water Massage On / Off

CALOS 2.0

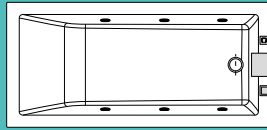

CALYPSO

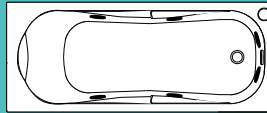

VOGUE

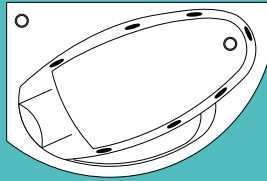

HYGIENE

WATER: Use products adapted to whirlpool baths to disinfect the water circuit: to disinfect the water circuit: fill your bathtub, pour the product into the water into the bathtub water and start the the Water massage



Adjustable water jet

WHIRLPOOL

HYDRO + Disinfection

Water massage system
 - 6 adjustable side water jets
 550 W (7 jets for the MODEL Vogue)

 Variable intensity water massage with the possibility of stopping at a specific intensit

 Disinfection programme

CALOS 2.0

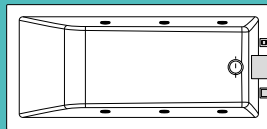

CALYPSO

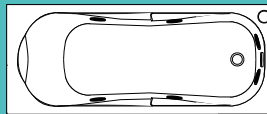

VOGUE

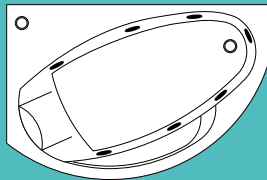

HYGIENE

WATER: Disinfection programme for pipes Water. Use products suitable for whirlpool baths to fill the to fill the tank provided for this purpose





Adjustable water jet

AIRPOOL AND WHIRLPOOL

HYDRO PLUS

Mixed massage system
 - 12 bottom air injectors
 400 W
 - 6 adjustable side water jets
 550 W (7 JETS for the MODEL Vogue)

 Continuous or alternating air massage

 Variable intensity water massage with the possibility of stopping at a specific intensit

 Disinfection programme

CALOS 2.0

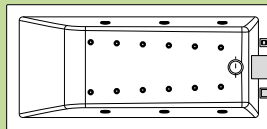

CALYPSO

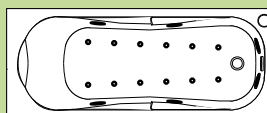

VOGUE

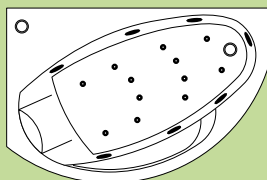

HYGIENE

AIR: Drying of air ducts at the end of the bath

WATER: Disinfection programme for pipes Water. Use products suitable for whirlpool baths to fill the to fill the tank provided for this purpose



Air injector

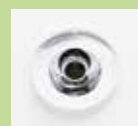



Adjustable water jet

WHIRLPOOL

HYDRO + DISINFECTION

Water massage system
- 6 adjustable side water jets
550 W

-  Variable intensity water massage with the possibility of stopping at a specific intensity
-  Disinfection programme

IRIS

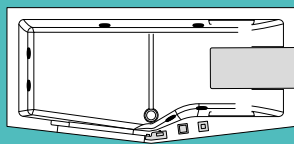

HYGIENE

EAU : Disinfection programme des conduits Eau. Utilisez les produits adaptés aux BATHs BATH pour remplir le réservoir prévu à cet effet

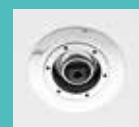



Adjustable water jet

AIRPOOL AND WHIRLPOOL

HYDRO PLUS

Mixed massage system
- 16 bottom air injectors
400 W
- 6 adjustable side JETS
550 W

-  Continuous or alternating air massage
-  Variable intensity water massage with the possibility of stopping at a specific intensity
-  Disinfection programme

IRIS

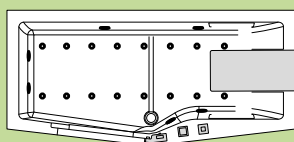

HYGIENE

AIR: Drying of air ducts at the end of the bath

EAU : Disinfection programme des conduits Eau. Utilisez les produits adaptés aux BATHs BATH pour remplir le réservoir prévu à cet effet

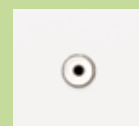

Air injector

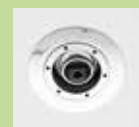

Adjustable water jet



COLLECTION NOVOTECH

EXCLUSIVE DESIGN AND NOBLE MATERIALS

This exclusive collection is a real gem. Made of Novotech, a material with a high percentage of natural mineral fillers and high purity resins, it offers 2 models of bathtubs with soft and sinuous shapes. Particularly solid, these bathtubs have surfaces with a silky touch. A real pleasure for the eyes and the senses!



The interior of the bathtubs is finished in Matt white. The exterior can be customised in 18 colours to suit the most refined tastes. It is up to you to choose between warm and enveloping tones or strong and decisive ones.



The interior of the BATHs is finished in Matt white. The exterior can be customised in 18 colours to suit the most refined tastes. It is up to you to choose between warm and enveloping tones or strong and decisive ones.



The Natural Air system that can be added to your bathtub from the Novotech collection offers the CARE massage with micro-bubbles of air with a regenerating and relaxing effect. To allow you to enjoy your wellness experience, the interior shapes of the bathtubs have been designed to offer you optimal immersion.



To create an intimate atmosphere, the bathtubs can optionally be equipped with LED lighting.

INFINITIVE

ÎLOT BATH

VERSIONS	EQUIPMENT	STANDARD WITHOUT SYSTEM BATH	NATURAL AIR MICRO-BUBBLE SYSTEM AIR NATURAL AIR
TO BE INSTALLED ALONE	click-clack emptying	•	
AVEC MEUBLE ET ROBINETTERIE	click-clack emptying	•	•

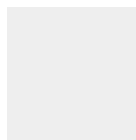

White mat

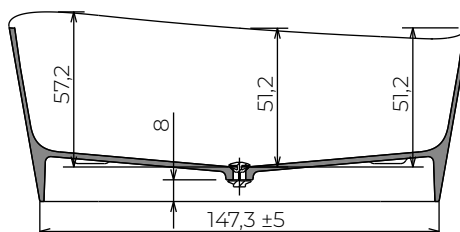
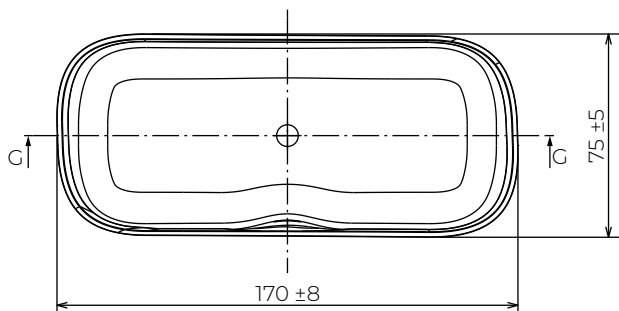

MODEL	WEIGHT	CAPACITY
170x75	135 kg	360 litres

EXTERIOR FINISH OF THE BATHTUB AND CONSOLE

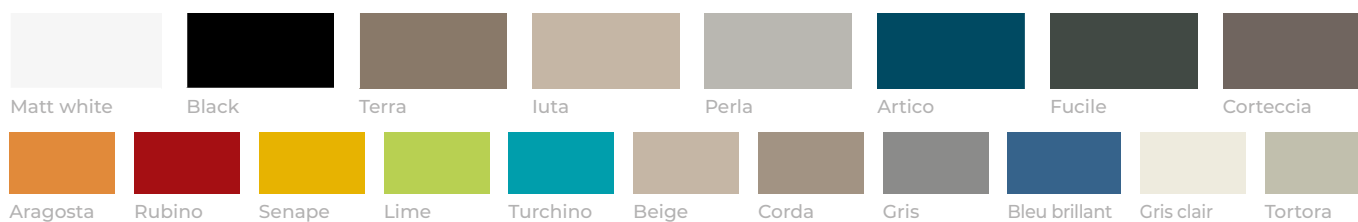

CONSOLE FINISHES

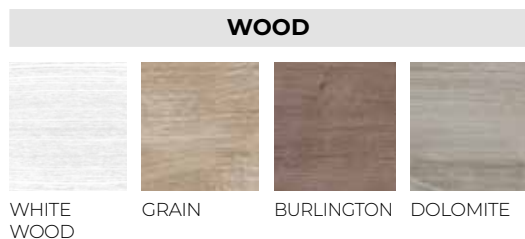

CONSOLE VERSIONS



OPTIONS



PERIMETER LED LIGHTING

INFINITIVE



SHIP

BATH ÎLOT

VERSIONS	EQUIPMENT	STANDARD WITHOUT SYSTEM BATH	NATURAL AIR MICRO-BUBBLE SYSTEM AIR NATURAL AIR
À POSER SEULE	click-clack emptying	•	
AVEC MEUBLE ET ROBINETTERIE	click-clack emptying	•	•

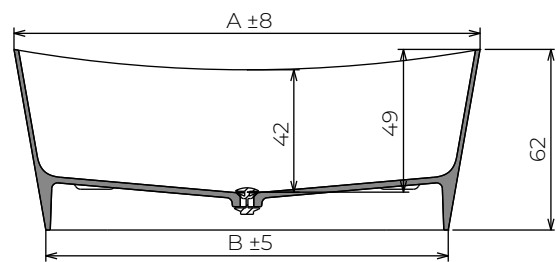
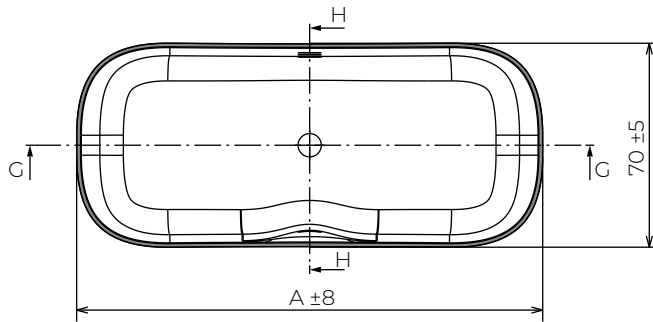
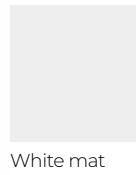

MODEL	A	B	WEIGHT	CAPACITY
150x70	150 cm	128 cm	105 kg	260 litres
160x70	160 cm	138 cm	115 kg	290 litres

EXTERIOR FINISHES OF THE BATH AND CONSOLE

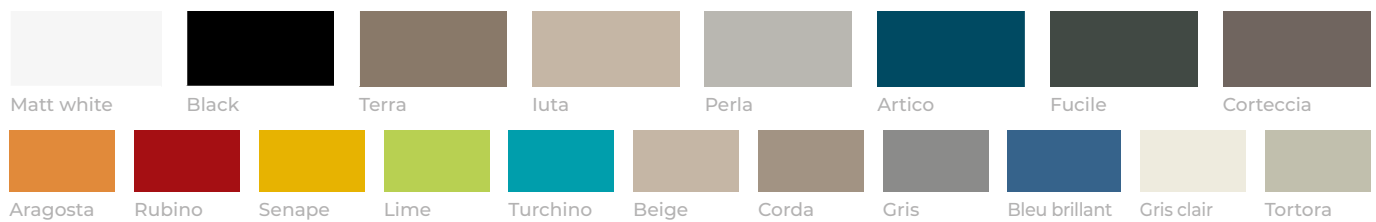

CONSOLE FINISHES



CONSOLE VERSIONS



OPTIONS



PERIMETER LED LIGHTING

SHIP



COLLECTION **NOVOTECH**

MASSAGE SYSTEM

NATURAL AIR

NATURAL AIR

Micro air bubble massage system

- 1 Natural Air Diffuser
1 050 W



Diffusion of micro air bubbles in the bath water
On/off operation



SPOT LED
Diffusion de la lumière white

INFINITIVE

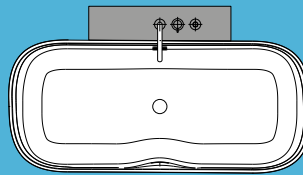

SHIP

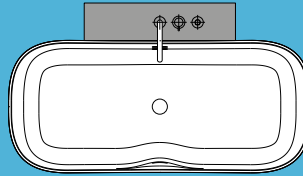

Natural Air Diffuser
Led white



Diffuser
NATURAL AIR





CONFORT			
Frame self-supporting	Headrest	Drain	Ordering



STILE

170x70 cm
170x75 cm
180x80 cm
180x110 cm
190x90 cm



STILE C

135x135 cm



**DIVINA
DIVINA 35**

160x70 cm
170x70 cm
170x75 cm
180x80 cm
180x100 cm
190x90 cm



**DIVINA F
DIVINA F 35**

180x80 cm



DIVINA C

140x140 cm



DIVINA O

165x98 cm



DIVINA W

180x80 cm



DIVINA DUAL

190x140 cm

STYLE

For installation with feet			automatic	
With self-supporting frame	yes	yes	automatic	
HYDRO AIR	yes	yes	automatic	Keyboard touch screen
WHIRLPOOL	yes	yes	automatic	Keyboard touch screen
WHIRLPOOL + DISINFECTION+ LIGHT	yes	yes	automatic	Keyboard touch screen
HYDRO PLUS	yes	yes	automatic	Keyboard touch screen
NATURAL AIR + WHIRLPOOL	yes	yes	automatic	Keyboard touch screen

DIVINA

For installation with feet			clic-clac	
With self-supporting frame	yes	yes	clic-clac	
HYDRO AIR	yes	yes	clic-clac	Keyboard touch screen
HYDRO	yes	yes	clic-clac	Keyboard touch screen
HYDRO PLUS	yes	yes	clic-clac	Keyboard touch screen
NATURAL AIR	yes	yes	clic-clac	Keyboard touch screen
NATURAL AIR + WHIRLPOOL	yes	yes	clic-clac	Keyboard touch screen

DIVINA DUAL

With self-supporting frame	yes	yes x2	click-clack (button on tap)	
WHIRLPOOL	yes	yes x2	click-clack (button on tap)	Keyboard touch screen
WHIRLPOOL + CASCADE	yes	yes x2	click-clack (button on tap)	Keyboard touch screen
WHIRLPOOL + AIRPOOL	yes	yes x2	click-clack (button on tap)	Keyboard touch screen
NATURAL AIR + WHIRLPOOL	yes	yes x2	click-clack (button on tap)	Keyboard touch screen
NATURAL AIR + WHIRLPOOL + CASCADE	yes	yes x2	click-clack (button on tap)	Keyboard touch screen

WATER		AIR		NATURAL AIR		CASCADE	WELLNESS			MAINTENANCE	
Pumps	Jets	Blower	Diffusers	Pumps	Diffusers	Pumps	Music	Chromolight	Temperature stabilising heater	Drying automatic (Air)	Disinfection (Water)

		400 W	16 air injectors							yes	
550 W	6 jets adjustable										
550 W	6 jets adjustable						Bluetooth	Backlit jets			Automatic programme
900 W	8 jets adjustable 6 micro-buses dorsal	400 W	10 air injectors				Bluetooth	Backlit jets		yes	Automatic programme
550 W	6 jets adjustable			1.050 W	1 diffuser		Bluetooth	Backlit jets			Automatic programme

		400 W	16 air injectors							yes	
900 W	6 buses lame d'eau										
900 W	6 buses lame d'eau	400 W	16 air injectors				Bluetooth	Backlit jets		yes	
				1.050 W	1 diffuser			Diffuser LED WHITE			
900 W	6 buses lame d'eau			1.050 W	1 diffuser		Bluetooth	Backlit jets			

900 W + 900 W	8 buses lame d'eau										
900 W + 900 W	8 buses lame d'eau					550 W	Bluetooth	Backlit jets			Automatic programme
900 W + 900 W	8 buses lame d'eau	400 W	20 air injectors				Bluetooth	Backlit jets		yes	Automatic programme
900 W + 900 W	8 buses lame d'eau			1.050 W	2 diffusers		Bluetooth	Backlit jets	1.300 W		Automatic programme
900 W + 900 W	8 buses lame d'eau			1.050 W	2 diffusers	550 W	Bluetooth	Backlit jets	1.300 W		Automatic programme

CONFORT			
Frame self-supporting	Headrest	Drain	Ordering



SENSE 3 2.0
chaise-longue
170x70 cm
170x75 cm
180x80 cm
190x80 cm



SENSE 4 2.0
flat bottom
170x70 cm
170x75 cm
180x80 cm
190x80 cm



SENSE DUAL
193x140 cm



CALOS 2.0
150x70 cm
160x70 cm
170x70 cm
170x75 cm
170x80 cm
180x80 cm



CALYPSO
150x70 cm
160x70 cm
170x70 cm
170x75 cm
170x80 cm
180x80 cm



VOGUE
150x85 cm
165x85 cm



IRIS
160x70/80 cm
170x70/80 cm
180x75/85 cm



INFINITIVE
170x75 cm



SHIP
150x70 cm
160x70 cm

SENSE 2.0

For installation with feet				
With self-supporting frame	yes	yes	automatic	
HYDRO AIR	yes	yes	automatic	Keyboard touch screen
WHIRLPOOL + DISINFECTION	yes	yes	automatic	Keyboard touch screen
WHIRLPOOL + DISINFECTION + LIGHT	yes	yes	automatic	Keyboard touch screen
HYDRO PLUS	yes	yes	automatic	Keyboard touch screen
NATURAL AIR + WHIRLPOOL	yes	yes	automatic	Keyboard touch screen

SENSE DUAL

With self-supporting frame	yes	yes x2	automatic	
HYDRO PLUS	yes	yes x2	automatic	Clavier sensitif

Classic

For installation with feet				
With self-supporting frame	yes	yes	automatic	
HYDRO	yes	yes	automatic	Keyboard electronic
HYDRO + Disinfection	yes	yes	automatic	Keyboard electronic
HYDRO PLUS	yes	yes	automatic	Keyboard electronic

CONFORT

With self-supporting frame	yes	yes	automatic	
HYDRO + DISINFECTION	yes	yes	automatic	Keyboard electronic
HYDRO PLUS	yes	yes	automatic	Keyboard electronic

NOVOTECH

Standard			clic-clac	
NATURAL AIR			clic-clac	

WATER		AIR		NATURAL AIR		CASCADE	WELLNESS			MAINTENANCE	
Pumps	Jets	Blower	Diffusers	Pumps	Diffusers	Pumps	Music	Chromolight	Temperature stabilising heater	Drying automatic (Air)	Disinfection (Water)

		400 W	16 air injectors					Spot multicolore		yes	
550 W	8 jets adjustable						Bluetooth	Backlit jets			Automatic programme
550 W	8 jets adjustable						Bluetooth	Backlit jets			Automatic programme
900 W	8 buses réglables 6 micro-buses dorsales	400 W	16 air injectors				Bluetooth	Backlit jets	1.300 W	yes	Automatic programme
550 W	6 jets adjustable			1.050 W	1 diffuseur		Bluetooth	Backlit jets			Automatic programme

550 W + 550 W	10 jets	400 W	14 air injectors				Bluetooth	Multicolour LED strip	1.450 W	yes	Automatic programme

550 W	6 adjustable water jets										
550 W	6 adjustable water jets										Automatic programme
550 W	6 adjustable water jets	400 W	12 air injectors							yes	Automatic programme

550 W	6 adjustable water jets										Automatic programme
550 W	6 adjustable water jets	400 W	12 air injectors							yes	Automatic programme

				1.050 W	1 diffuseur			LED WHITE			







Novellini UK Ltd

Unit 11, Caxton Court - Porters Wood - St Albans - Hertfordshire - AL3 6XT
Tel: 01727-229922 - Fax: 01727-838232 - info-uk@novellini.com

Designed and
manufactured
in **ITALY**



www.novellini.com



www.novellini.com/facebook



www.novellini.com/instagram



www.novellini.com/YouTube



www.novellini.com/Linkedin



www.novellini.com/Pinterest